



## **APPENDIX 4-4**

**AGEC COOLE WIND FARM CABLE  
ROUTE PRIORITY AREA SURVEY**

## **COOLE WIND FARM CABLE ROUTE PRIORITY AREA SURVEY**

**Prepared for:**

**McCarthy Keville O'Sullivan Ltd**


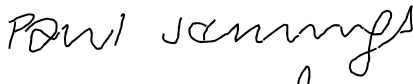
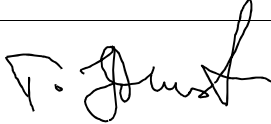

**April 2017**

The Grainstore  
Singletons Lane  
Bagenalstown  
Co. Carlow  
R21 XA66  
Ireland

E-mail: [info@agec.ie](mailto:info@agec.ie)

DOCUMENT APPROVAL FORM

Document title:	Cooler Wind Farm Cable Route Priority Area Survey		
AGEC Document Reference:	1608_077	Document Revision:	1
Note:			
AGEC Document Number	Document Revision.	Amendment/Comment	
1608_069	0	Draft for comment	
1608_077	1		

Task	Nominated authority	Approved (signature)
Prepared by	Author: Billy Murphy	
Checked by	Geotechnical Project Manager: Dr. Paul Jennings	
Approved by	Geotechnical Project Director: Turlough Johnston	
Quality check	Quality Manager: Marion English	

*This document has been prepared for the titled project and should not be relied upon or used for any other project without an independent check being carried out as to its suitability and prior written authority of AGECE being obtained. AGECE accepts no responsibility or liability for the consequences of this document being used for a purpose other than the purposes for which it was commissioned. Any person using or relying on the document for such other purposes agrees, and will by such use or reliance be taken to confirm his agreement to indemnify AGECE for all loss or damage resulting therefrom. AGECE accepts no responsibility or liability for this document to any party other than the person by whom it was commissioned.*

## TABLE OF CONTENTS

	<u>Page No.</u>
TITLE SHEET	i
DOCUMENT APPROVAL FORM	ii
ACRONYMS AND DEFINITIONS	iii
TABLE OF CONTENTS	
1 INTRODUCTION	1
1.1 General	1
1.2 Scope and Objective	1
2 SURVEY RESULTS	2
2.1 General	2
2.2 Survey Details	2
3 FINDINGS OF SURVEY	3
3.1 General	3
3.2 Peat Depth	3
3.3 Shear Vane Strength of Peat	3
4 SUMMARY	4
4.1 Peat Less Than 1.25 m	4
4.2 Peat Between 1.25 m and 4.25 m	4
4.3 Peat Greater Than 4.25 m	4
4.4 Stability Analysis	4
5 CONCLUSIONS	5
 FIGURES (at end of main text)	
Figure 1	Peat Depth Contour Plan – Priority Area 1
Figure 2	Peat Depth Contour Plan – Priority Area 2
Figure 3	Peat Depth Contour Plan – Priority Area 3
Figure 4	Undrained Shear Strength (Cu) Profile for Peat with Depth
Figure 5	Typical Trench Section for Peat / Soft Ground (<1250 mm)
Figure 6	Typical Trench Section for Peat / Soft Ground (>1250 mm to <4250 mm)
Figure 7	Stability Check on Road with Trench & Construction Plant
 TABLES	
Table 1	Survey Results

## **1 INTRODUCTION**

### **1.1 General**

Applied Ground Engineering Consultants Ltd (AGEC) were requested by McCarthy Keville O'Sullivan (McCarthy KOS) to carry out a walkover survey and carry out a peat stability assessment of roads located on bog ramparts along three (3) sections of the proposed underground cable route for the Coole Wind Farm project. The total length of the proposed route is 25.8 kilometres (km) with approximately 8 km comprising road over bogs of varying depth (3 priority areas). These areas were identified by Westmeath County Council roads engineer.

The surrounding landscape is predominately flat with land-use comprising forestry, agricultural land and both intact and cutaway peatland. The Geological Survey of Ireland (GSI, 2006 & 2016) geological plans indicate that the soils and subsoils along the gridline route generally consist of Till, Sands and Gravels and Peat overlying cherty limestone, minor shale of the Derravaragh Cherts formation as well as dark limestone and shale of the Lucan formation.

### **1.2 Scope and Objective**

The report includes the results of a walkover survey of the ground conditions along the three (3) priority areas for the proposed cable route as well as the results of an indicative stability analysis in accordance with Eurocode 7 (Design Approach 1, Condition 2) on a typical section of the road embankment with a trench located at the edge of the road embankment (for example) and construction plant located on the road (see Figure 7). It also includes typical trench details for sections of the underground cable route and possible construction options for areas of deeper peat.

The report includes the following:

- (1) Probing data from the verges on both sides of the road at approximately 200 m intervals along the three (3) priority areas to determine the ground conditions including the thickness of peat and / or soft ground.
- (2) Shear vane test results in peat at various locations along the three (3) priority areas ;
- (3) Salient observations on ground conditions and drainage.
- (4) The results of peat stability analysis carried out on a typical road section to determine if a cable trench along with construction equipment on the road would cause instability of the road.
- (5) Typical construction methods for the cable trench and possible options for the cable trench construction in areas of deeper peat.

## **2 SURVEY RESULTS**

### **2.1 General**

The survey was carried out on April 4<sup>th</sup> and 5<sup>th</sup> 2017. The survey comprised a walkover of the proposed cable route in three (3) priority areas by a geotechnical engineer experienced in peat assessment.

The proposed cable route comprises buried high voltage cables placed within the road or the adjacent verge.

The purpose of the survey was to establish the ground conditions along the route in the three (3) areas of concern with respect to construction of the buried cables and the potential effects on the road.

### **2.2 Survey Details**

The survey was carried out from south to north with probes completed at about 200 m intervals with in-situ vanes completed at various locations. All locations were co-ordinated by hand-held GPS and on site measurements.

### **3 FINDINGS OF SURVEY**

#### **3.1 General**

The walkover survey was completed along the three (3) priority areas of the proposed cable route. The topography in the area is generally flat with the land use comprising a mix of farm land, bog and forestry. Where the deeper areas of peat were encountered, the road construction is likely floating. The roads were generally in fair condition with the road surface undulating in places with little surface cracking / potholes. During the inspection, road traffic comprised mixed vehicles types including heavy lorries.

The survey results are presented in Table 1. At most survey point locations, a reading was taken in each verge, this is designated as E and W or N and S in Table 1.

#### **3.2 Peat Depth**

Peat probing was carried out along both sides of the road within the verge to determine peat depths. The results of the peat depth survey are shown on peat depth contour plans (Figures 1 to 3).

Peat depths range from no penetration up to about 6.3 m with an average depth of about 1.8 m, which excludes no penetration reading.

The probes give an indication of the depth of peat expected to be present, however, it was noted that due to the well-drained nature of the peat that it became hard to advance the probes at depth and the depth values encountered may possibly be deeper than recorded.

At about forty-seven (47) of the eighty (80) points no penetration was recorded from the probing. Even though no penetration generally indicates a lack of peat, it should be noted that the road verge may contain made ground consisting of gravel / stone or other obstructions that prevented the probes from penetrating the ground.

#### **3.3 Shear Vane Strength of Peat**

Shear vane measurements were taken at various locations along the proposed route within the verges using a Geonor H-10 shear vane. The purpose of the testing was to determine the indicative strength of the peat. The indicative strength results are shown in Table 1.

The indicative strength results range from 20 to 80 kPa with an average of about 45 kPa. In comparison to shear vane results from other peat sites the results for the proposed cable route are relatively high. The relatively high peat strength is likely in part due to the roadside drainage which has allowed the peat to drain and consolidate over a period of time.

The indicative peat strength with depth is shown in Figure 4.

## 4 SUMMARY

A summary of the survey results for the three (3) priority sections of the proposed cable route are given below.

### 4.1 Peat Less Than 1.25 m

- About 75 % of the priority areas (see Figures 1 to 3) measured typical peat depths of less than 1.25 m.
- A typical cable trench detail is shown on Figure 5 which could be considered suitable for this condition. The trench could be located beside (road verge) or within the road.
- Trench support will be required during construction to maintain the integrity of the trench / road.

### 4.2 Peat Between 1.25 m and 4.25 m

- About 20 % of the priority areas (see Figures 1 to 3) measured typical peat depths of between 1.25 m and 4.25 m.
- A typical cable trench detail is shown on Figure 6 which could be considered suitable for this condition. The trench could be located beside (road verge) or within the road.
- This typical trench section will require an excavate and replace technique of up to 3 m below the base of the trench.
- Trench support will be required during construction to maintain the integrity of the trench / road.

### 4.3 Peat Greater Than 4.25 m

- About 5 % of the priority areas (see Figures 1 to 3) measured typical peat depths greater than 4.25 m with the maximum recorded peat depth of about 6.3 m.
- Various options to lay the cable in this area may include:
  - Light weight backfill to provide neutral buoyancy (floating trench);
  - Deep dig to competent stratum;
  - Mini-piles;
  - Peat stabilisation (e.g. Allu soil mixer); and
  - Vary trench route to avoid deeper peat (i.e. peat depth can vary across the road width).

### 4.4 Stability Analysis

An indicative stability analysis in accordance with Eurocode 7 (Design Approach 1, Condition 2) was carried out on a typical section of the road embankment with a trench located at the edge of the road embankment (for example) and construction plant located on the road (see Figure 7). The analysis examined the drained condition using typical soil parameters.

A calculated minimum factor of safety of 1.24 was achieved. The required minimum factor of safety is 1. The results indicate that the stability of the road will not be an issue with the trench in place. For detailed design, a number of different scenarios will be examined including stability during trench construction, various trench locations (beside (road verge) / in road) and also at different road sections.



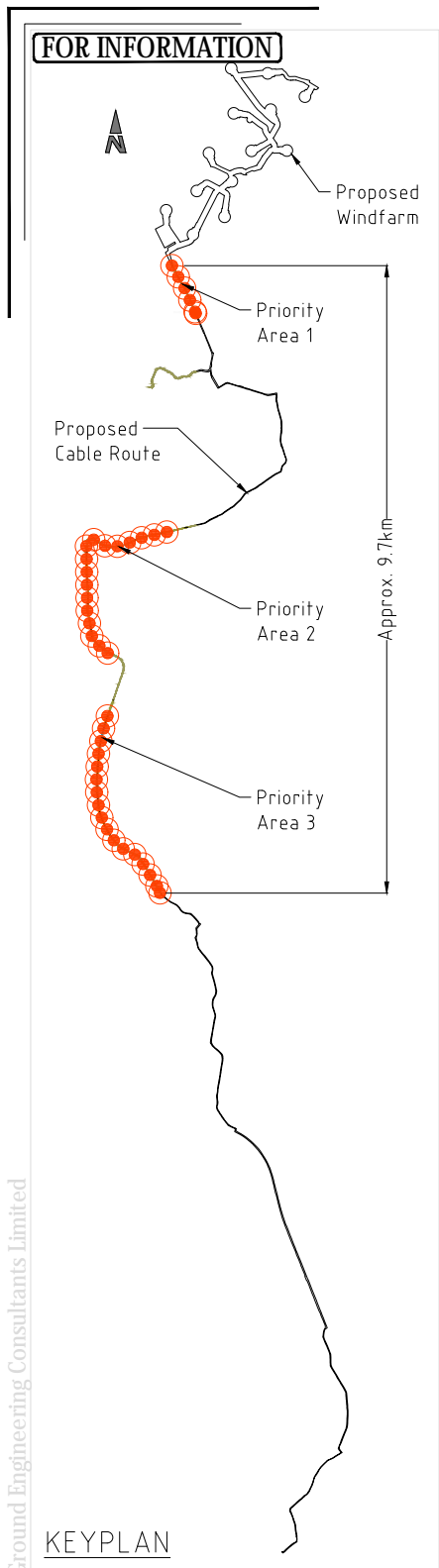
## 5 CONCLUSIONS

- (1) Based on the information obtained during the site walkover, installation of the cable trench within the road or road verges is feasible, provided proper construction techniques are followed to maintain the integrity of the roads on bog ramparts. Once the cable is laid in the roads, the trench will be backfilled to appropriate standards and the road surface reinstated as directed by Westmeath County Council.
- (2) Based on the information obtained during the site walkover, most of the priority sections of the proposed cable route can be constructed using typical trench details as shown in Figure 5 and 6.
- (3) There are sections of the proposed route where deeper peat was encountered that will need additional consideration regarding construction detail and measures before finalising construction plans, see options in Section 4.3.
- (4) It is recommended that the sections of deeper peat are reviewed on a section-by-section basis with the various options considered for these sections of the cable installation at the detailed design stage.
- (5) A stability analysis shows that the inclusion of the cable trench would not reduce the stability of the road embankment. For detailed design, further stability analysis will be carried out to verify the stability of the road embankment for a number of cable trench scenarios in order to choose the most appropriate construction solution.

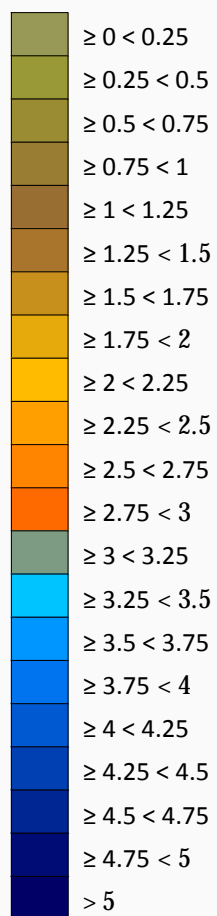
**FIGURES**

---



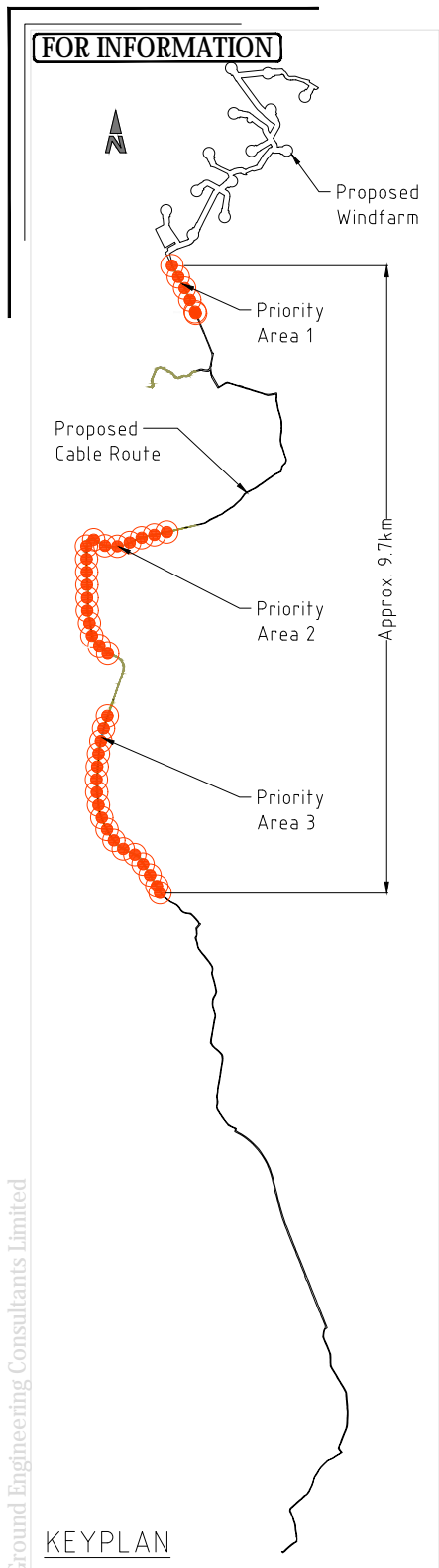


**Peat Depth Legend (mbgl):**

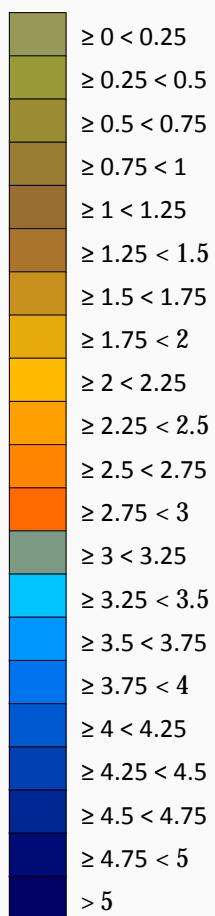


**Figure 1 - Peat Depth Contour Plan - Priority Area 1**



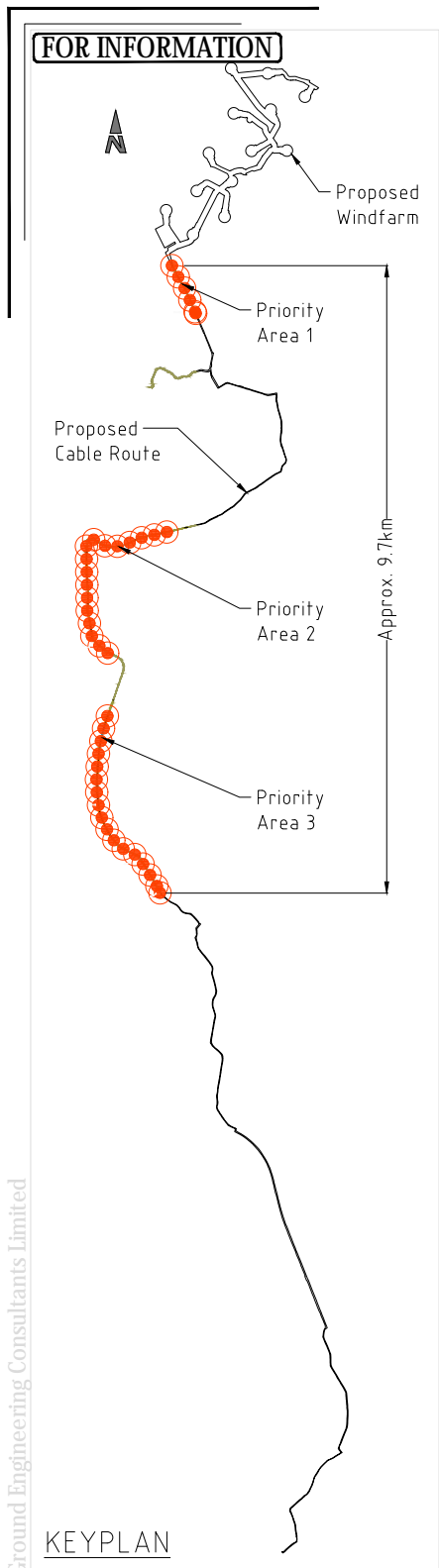


**Peat Depth Legend (mbgl):**



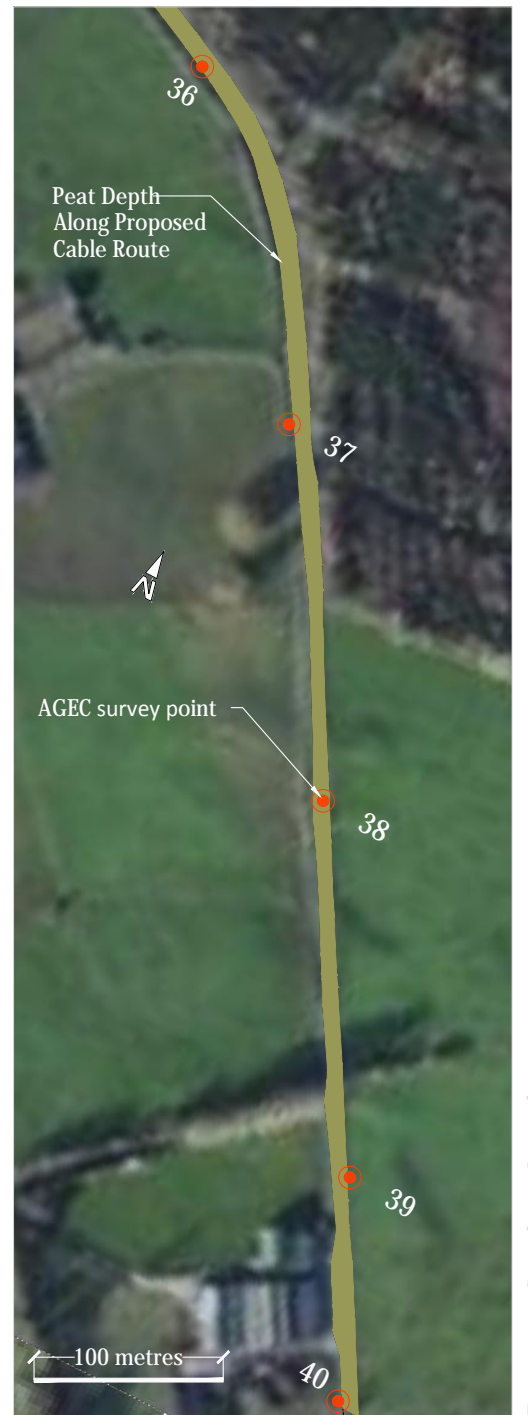
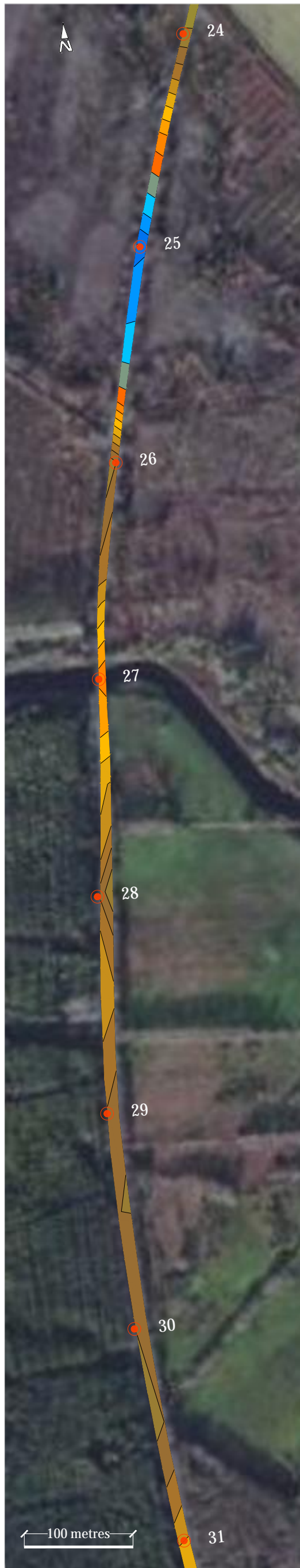
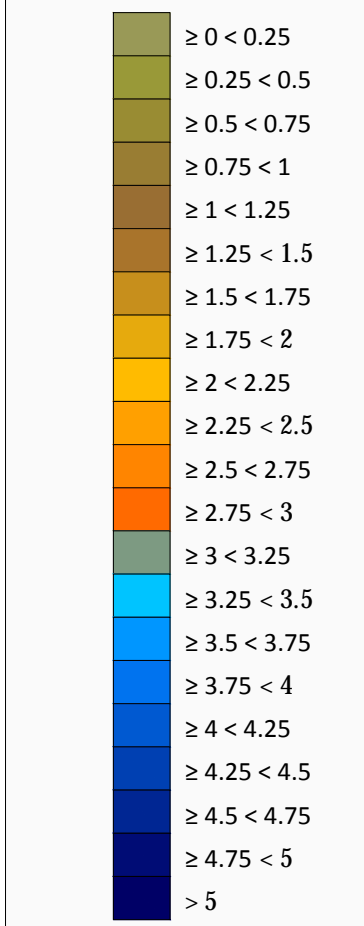
**Figure 2 - Peat Depth Contour Plan - Priority Area 2**





Applied Ground Engineering Consultants Limited

**Peat Depth Legend (mbgl):**

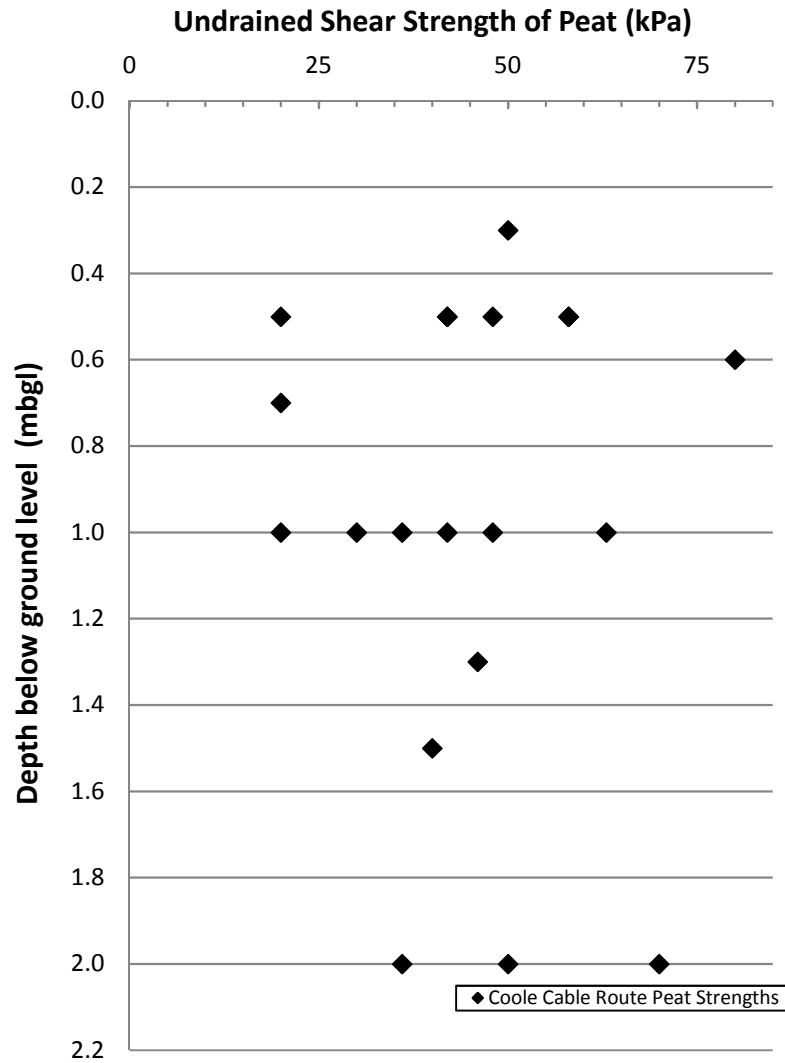


Applied Ground Engineering Consultants Limited

**Figure 3 - Peat Depth Contour Plan - Priority Area 3**





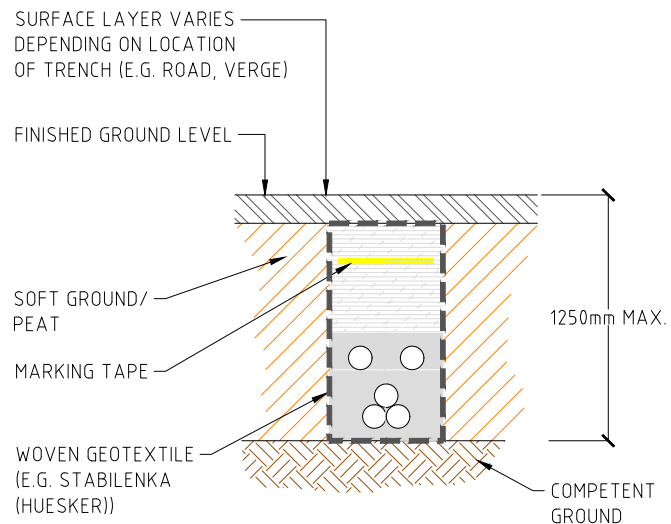


**Figure 4 Undrained Shear Strength ( $C_u$ ) Profile for Peat with Depth**

FOR INFORMATION

Applied Ground Engineering Consultants Limited

Applied Ground Engineering Consultants Limited

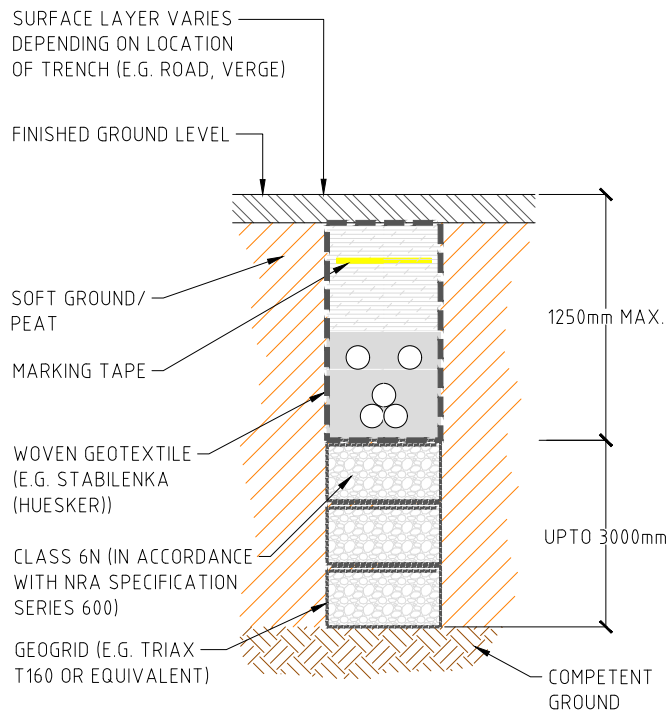


SOFT GROUND (<1250mm)

- PAVEMENT MATERIALS AND TRENCH REINSTATEMENT MATERIALS AS PER CABLE DESIGNERS REQUIREMENTS.
- TRENCH SUPPORT WILL BE REQUIRED DURING CONSTRUCTION TO MAINTAIN INTEGRITY OF THE TRENCH/ROAD.

Figure 5 - Typical Trench Section for Peat / Soft Ground (<1250mm)

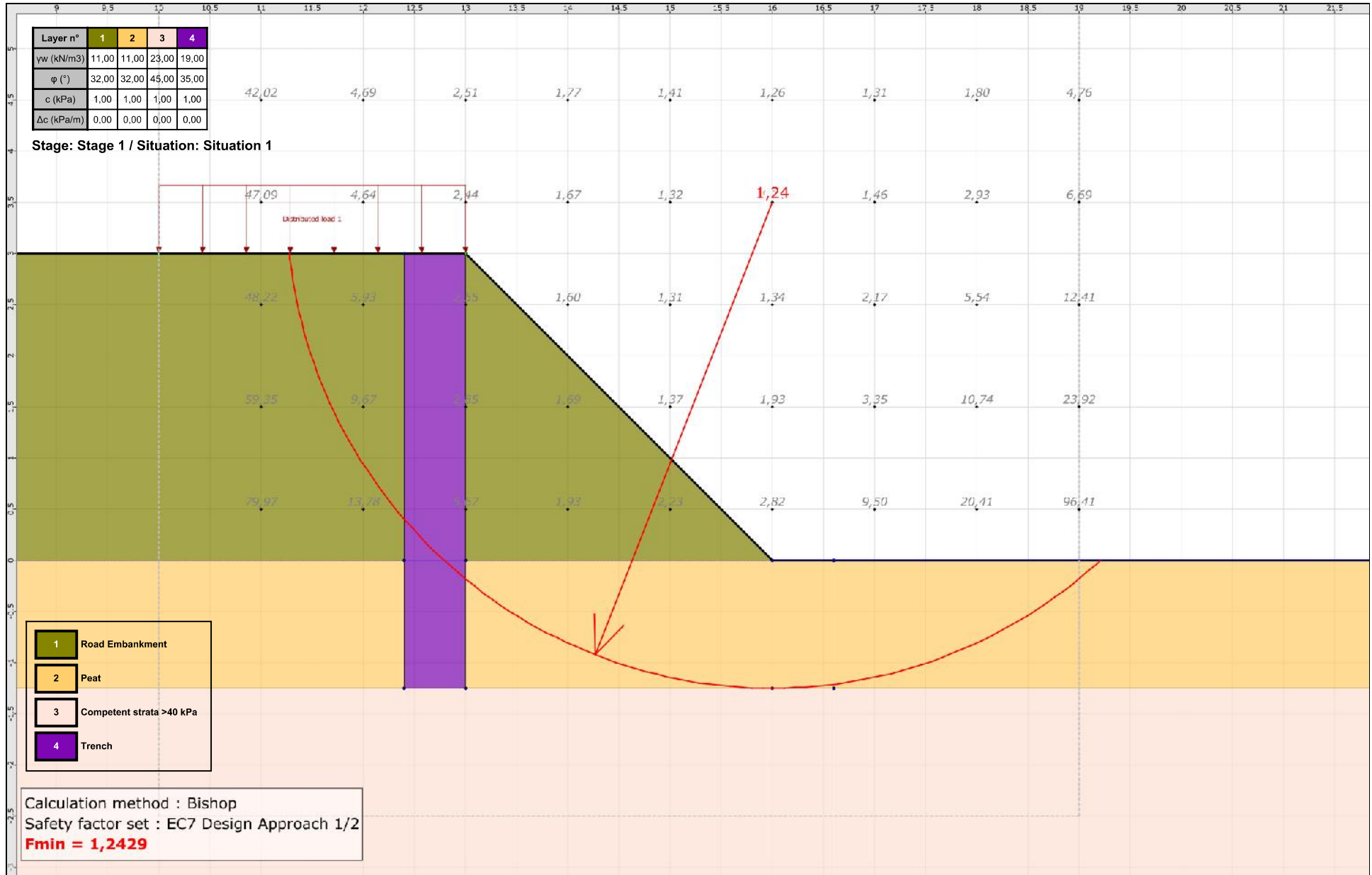
FOR INFORMATION



SOFT GROUND (>1250mm to <4250mm)

- PAVEMENT MATERIALS AND TRENCH REINSTATEMENT MATERIALS AS PER CABLE DESIGNERS REQUIREMENTS.
- TRENCH SUPPORT WILL BE REQUIRED DURING CONSTRUCTION TO MAINTAIN INTEGRITY OF THE TRENCH/ROAD.

Figure 6 - Typical Trench Section for Peat / Soft Ground (>1250mm to <4250mm)



**TABLES**

---

**Table 1 Survey Results**

Point	Easting <sup>1</sup>	Northing <sup>1</sup>	Depth of Peat (m bgl)	Depth of test (m bgl)	Peat Strength (kPa)	Comment
1 E	639942	774293	0.9	0.5	48	Measured from bottom of embankment ~2 m from road. Embankment ~2.5 m high.
1 W	639932	774293	0.3	-	-	Measured from bottom of embankment ~2 m from road. Embankment ~2.5 m high.
2 E	640039	774118	1.8	1.0	36	Measured from bottom of embankment ~3 m from road. Embankment is ~2.5 m high.
2 W	640029	774118	0.2	-	-	Measured from bottom of embankment ~2.5 m from road. Embankment is ~2.5 m high.
3 E	640137	773944	- <sup>2</sup>	-	-	No penetration as far as ditch ~5 m from edge of road.
3 W	640127	773944	0.9	-	-	Measured from base of embankment ~3 m from road. Embankment is ~2 m high. Too many roots to do a vane.
4 E	640218	773761	- <sup>2</sup>	-	-	No penetration at bottom of embankment ~1.5 m from road. Embankment is ~1 m high.
4 W	640208	773761	- <sup>2</sup>	-	-	No penetration between road and ditch ~0.5 m from road.
5 E	640298	773578	- <sup>2</sup>	-	-	No penetration between road and fence ~2.5 m from road.
5 W	640288	773578	- <sup>2</sup>	-	-	No penetration between road and ditch ~1 m from road.
6 E	640309	773555	- <sup>2</sup>	-	-	No penetration between road and ditch ~1.5 m from road.
6 W	640299	773555	- <sup>2</sup>	-	-	No penetration between road and ditch ~1.5 m from road.
7 N	639859	770172	- <sup>2</sup>	-	-	No penetration under ditch on verge of road. Bog on other side of ditch.
7 S	639859	770162	0.9	-	-	No penetration between road and 4 m from road. Open bog area. Couldn't turn vane.
8 N	639663	770128	- <sup>2</sup>	-	-	No penetration under ditch on verge of road. Bog on other side of ditch.
8 S	639663	770118	- <sup>2</sup>	-	-	Concrete yard for stockpiling peat.
9 N	639468	770085	- <sup>2</sup>	-	-	No penetration between road and ditch ~2 m from road.

Point	Easting <sup>1</sup>	Northing <sup>1</sup>	Depth of Peat (m bgl)	Depth of test (m bgl)	Peat Strength (kPa)	Comment
9 S	639468	770075	0.9	0.5	20	Measured ~3 m from road.
10 N	639283	770011	- <sup>2</sup>	-	-	No penetration between road and ditch ~1 m from road. Farm field other side of ditch.
10 S	639283	770000	- <sup>2</sup>	-	-	No penetration between road and ditch ~ 1 m from road. Farm field other side of ditch.
11 N	639093	769953	- <sup>2</sup>	-	-	No penetration between road and ditch ~0.5 m from road. Farm field other side of ditch.
11 S	639093	769943	- <sup>2</sup>	-	-	No penetration between road and ditch ~0.5 m from road. Farm field other side of ditch.
12 N	638901	769959	- <sup>2</sup>	-	-	No penetration between road and ditch ~0.5 m from road. Farm field other side of ditch.
12 S	638901	769949	- <sup>2</sup>	-	-	No penetration between road and ditch ~0.5 m from road. Farm field other side of ditch.
13	638726	770051	-	-	-	On narrow bend near bridge (over river).
14	638613	769950	-	-	-	On narrow bend near bridge (over river).
15 E	638621	769750	2.0	-	-	Measured ~1.5 m from road.
15 W	638611	769750	3.1	1.0	30	Measured ~2 m from road.
16 E	638623	769550	1.8	1.0	63	Measured ~3 m from road.
16 W	638613	769550	1.8	-	-	Measured ~2 m from road. Stream crossing at 16.
17 E	638626	769350	0.9	-	-	Measured ~3 m from road.
17 W	638616	769350	- <sup>2</sup>	-	-	No penetration up to ~4 m from road.
18 E	638628	769150	- <sup>2</sup>	-	-	No penetration up to ~6 m from edge of road. Bog other side of ditch line.
18 W	638618	769150	1.8	1.0	48	Measured ~3 m from road. Bog other side of ditch line.
19 E	638631	768950	1.5	0.3	50	Measured ~3 m from road. Bog other side of ditch line.



Point	Easting <sup>1</sup>	Northing <sup>1</sup>	Depth of Peat (m bgl)	Depth of test (m bgl)	Peat Strength (kPa)	Comment
19 W	638621	768950	1.5	0.5	58	Measured ~3 m from road. Bog other side of ditch line.
20 E	638664	768753	2.9	1.0	20	Measured ~3 m from road. Bog other side of ditch line.
20 W	638654	768753	0.9	0.5	58	Measured ~3 m from road. Bog other side of ditch line.
21 E	638703	768557	- <sup>2</sup>	-	-	No penetration between road and ditch ~ 1 m from road. Farm field other side of ditch.
21 W	638693	768557	- <sup>2</sup>	-	-	No penetration between road and ditch ~ 1 m from road. Farm field other side of ditch.
22 E	638818	768407	- <sup>2</sup>	-	-	No penetration between road and ditch ~ 1 m from road. Farm field other side of ditch.
22 W	638808	768407	- <sup>2</sup>	-	-	No penetration between road and ditch ~ 1 m from road. Farm field other side of ditch.
23 E	638948	768294	- <sup>2</sup>	-	-	No penetration between road and ditch ~ 1 m from road. Farm field other side of ditch.
23 W	638938	768294	- <sup>2</sup>	-	-	No penetration between road and ditch ~ 1 m from road. Farm field other side of ditch.
24 E	638943	767318	0.5	-	-	Measured ~2.5 m from road. Bog on other side of ditch.
24 W	638933	767318	0.5	-	-	Measured ~2.5 m from road. Bog on other side of ditch.
25 E	638884	767127	4.0	1.5	40	Measured ~2 m off road.
25 W	638874	767127	6.3	2.0	70	Measured ~3 m off road.
26 E	638842	766932	2.5	0.5	42	Measured ~3 m off road.
26 W	638832	766932	- <sup>2</sup>	-	-	No penetration between road and ditch ~2 m off road.
27 E	638806	766735	2.9	0.5	42	Measured ~ 3 m off road. River crossing at 27.
27 W	638796	766735	0.5	-	-	Measured ~ 3 m off road. River crossing at 27.
28 E	638785	766536	- <sup>2</sup>	-	-	No penetration between road and ditch ~3 m from road.

Point	Easting <sup>1</sup>	Northing <sup>1</sup>	Depth of Peat (m bgl)	Depth of test (m bgl)	Peat Strength (kPa)	Comment
28 W	638775	766536	4.5	2.0	50	Measured ~2.5 m from road.
29 E	638774	766337	0.9	-	-	Measured ~3 m off road.
29 W	638764	766337	1.5	1.3	46	Measured at bottom of ditch ~2.5 m from road. Ditch is ~2 m high.
30 E	638779	766137	1.5	-	-	Measured ~1 m off road.
30 W	638769	766137	- <sup>2</sup>	-	-	No penetration between road and ditch ~3 m from road.
31 E	638805	765939	2.3	0.6	80	Measured ~1 m off road.
31 W	638795	765939	- <sup>2</sup>	-	-	No penetration between road and ditch ~3 m from road.
32 E	638856	765746	1.5	1.0	42	Measured ~1 m off road.
32 W	638846	765746	4.3	2.0	36	Measured ~2 m off road.
33 E	638938	765565	0.2	-	-	Measured ~2 m off road.
33 W	638928	765565	2.0	0.7	20	Measured at bottom of ditch ~2 m off road. Ditch is ~1 m high.
34 E	639042	765394	- <sup>2</sup>	-	-	No penetration between road and ditch ~1 m from road. Farm field other side of ditch.
34 W	639032	765394	- <sup>2</sup>	-	-	No penetration between road and ditch ~1 m from road. Farm field other side of ditch.
35 E	639188	765263	- <sup>2</sup>	-	-	No penetration between road and ditch ~1 m from road. Farm field other side of ditch.
35 W	639178	765263	- <sup>2</sup>	-	-	No penetration between road and ditch ~1 m from road. Farm field other side of ditch.
36 E	639367	765173	- <sup>2</sup>	-	-	Small forested area. No penetration.
36 W	639357	765173	- <sup>2</sup>	-	-	No penetration between road and ditch ~1 m from road. Farm field other side of ditch.
37 E	639495	765026	- <sup>2</sup>	-	-	Small forested area. No penetration.

Point	Easting <sup>1</sup>	Northing <sup>1</sup>	Depth of Peat (m bgl)	Depth of test (m bgl)	Peat Strength (kPa)	Comment
37 W	639485	765026	- <sup>2</sup>	-	-	Farm yard.
38 E	639603	764858	- <sup>2</sup>	-	-	No penetration between road and ditch ~1 m from road. Farm field other side of ditch.
38 W	639593	764858	- <sup>2</sup>	-	-	No penetration between road and ditch ~1 m from road. Farm field other side of ditch.
39 E	639707	764688	- <sup>2</sup>	-	-	No penetration between road and ditch ~1 m from road. Farm field other side of ditch.
39 W	639697	764688	- <sup>2</sup>	-	-	No penetration between road and ditch ~1 m from road. Farm field other side of ditch.
40 E	639756	764580	- <sup>2</sup>	-	-	No penetration between road and ditch ~1 m from road. Farm field other side of ditch.
40 W	639746	764580	- <sup>2</sup>	-	-	Farm yard.

Notes:

- (1) Coordinates approximate based on hand held GPS and on site measurements;
- (2) Unable to penetrate with probe.