

**Coole Wind Farm FI,
Co. Westmeath
Planning Permission Application Drawings**





Schedule of Drawings

Drawing No.	Drawing Title	Scale	Page Size
200445g – 01 FI	Location Context Map	1: 60,000	A3
200445g – 02 FI	Site Location Map	1: 60,000	A1
200445g – 03 FI	Site Location Key Plan	1: 30,000	A1
200445g – 04 FI	Site Location Plan 1 of 9	1: 5,000	A1
200445g – 05 FI	Site Location Plan 2 of 9	1: 5,000	A1
200445g – 08 FI	Site Location Plan 5 of 9	1: 5,000	A1
200445g – 09 FI	Site Location Plan 6 of 9	1: 5,000	A1
200445g – 10 FI	Site Location Plan 7 of 9	1: 5,000	A1
200445g – 11 FI	Site Location Plan 8 of 9	1: 5,000	A1
200445g – 12 FI	Site Location Plan 9 of 9	1: 5,000	A1
200445g – 13 FI	Site layout Key Plan B	1: 30,000	A1
200445g – 14 FI	Site Layout Sheet 1 of 24	1: 2,500	A1
200445g – 15 FI	Site Layout Sheet 2 of 24	1: 2,500	A1
200445g – 16 FI	Site Layout Sheet 3 of 24	1: 2,500	A1
200445g – 17 FI	Site Layout Sheet 4 of 24	1: 2,500	A1
200445g – 18 FI	Site Layout Sheet 5 of 24	1: 2,500	A1
200445g – 19 FI	Site Layout Sheet 6 of 24	1: 2,500	A1
200445g – 20 FI	Site Layout Sheet 7 of 24	1: 2,500	A1
200445g – 21 FI	Site Layout Sheet 8 of 24	1: 2,500	A1
200445g – 26 FI	Site Layout Sheet 13 of 24	1: 2,500	A1
200445g – 27 FI	Site Layout Sheet 14 of 24	1: 2,500	A1
200445g – 28 FI	Site Layout Sheet 15 of 24	1: 2,500	A1
200445g – 29 FI	Site Layout Sheet 16 of 24	1: 2,500	A1
200445g – 30 FI	Site Layout Sheet 17 of 24	1: 2,500	A1
200445g – 31 FI	Site Layout Sheet 18 of 24	1: 2,500	A1
200445g – 32 FI	Site Layout Sheet 19 of 24	1: 2,500	A1
200445g – 33 FI	Site Layout Sheet 20 of 24	1: 2,500	A1
200445g – 34 FI	Site Layout Sheet 21 of 24	1: 2,500	A1
200445g – 35 FI	Site Layout Sheet 22 of 24	1: 2,500	A1
200445g – 36 FI	Site Layout Sheet 23 of 24	1: 2,500	A1
200445g – 37 FI	Site Layout Sheet 24 of 24	1: 2,500	A1
200445g – 38 FI	Temporary Construction Compound	1: 500	A3
200445g – 39 FI	Substation Layout	1: 500	A3
200445g – 42A FI	Wind Turbine Range Elevations & Plan	1: 500	A1
200445g – 42B FI	97.5m hub and 77.5m blade Wind Turbine Elevations & Plan	1: 500	A1
200445g – 42C FI	100m hub and 75m blade Wind Turbine Elevations & Plan	1: 500	A1
200445g – 42D FI	100.5m hub and 74.5m blade Wind Turbine Elevations & Plan	1: 500	A1
200445g – 43 FI	Turbine Foundation Standard Detail	1: 200	A3
200445g – 59 FI	Peatland Optioned Lands	1: 10,000	A1
COLE d005.3.3	CLONAVA BRIDGE CROSSING PROPOSED OPTION C	1:25/ 1:125	A1
COLE d005.3.4	SHRUBBYWOOD BRIDGE CROSSING WH-L1825-002.00 PROPOSED OPTION B	1:100 / 1:25	A1
COLE d005.3.5	SHRUBBYWOOD BRIDGE CROSSING WH-L1825-002.00 PROPOSED OPTION C	1:100 / 1:25	A1
COLE d005.3.6	CLONAVA BRIDGE CROSSING WH-L1825-001.00 PROPOSED OPTION D	1:25 / 1:125	A1
COLE d005.3.7	CLONAVA BRIDGE CROSSING WH-L1825-001.00 PROPOSED OPTION E	1:25 / 1:125	A1
COLE d005.3.8	SHRUBBYWOOD BRIDGE CROSSING WH-L1825-002.00 PROPOSED OPTION D	1:100 / 1:25	A1
COLE d006.1.1	MULLINGAR SUBSTATION ILLUSTRATIVE PLAN	1: 100	A1
COLE d006.1.2	MULLINGAR SUBSTATION EXTENSION EQUIPMENT DETAILS	1: 100	A1

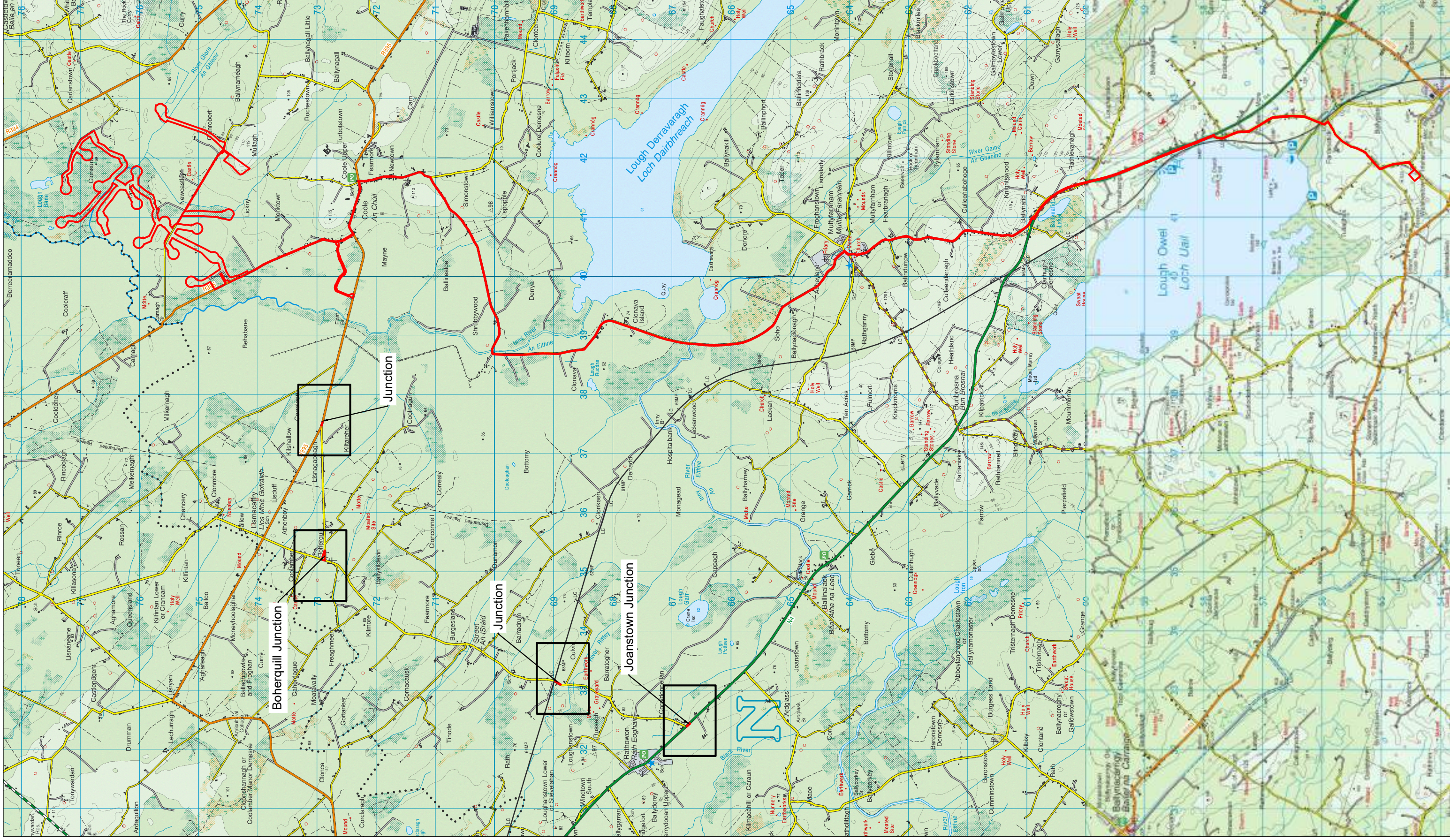

Drawing Legend

— Planning Application Boundary

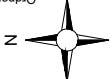

Ordnance Survey Ireland Licence No. CVAL50267517 © Ordnance Survey Ireland/Government of Ireland

DRAWING TITLE

Location Context Map

PROJECT TITLE: Coole Wind Farm Fl, Co. Westmeath

CHECKED BY: Meabhann Crowe

DRAWING BY: Joseph O'Brien

PROJECT NO: 200445g

SCALE: 1:60,000 @A3

DATE: 27.10.2022

OS SHEETS: OS2226, OS2426



MKO
 Planning and
 Environmental
 Consultants
 Turn Road, Cobey
 Island, HI W841
 +353 (0) 91 725611
 email: info@www.mko.ie
 Website: www.mko.ie

Project Design Drawing Notes

1. Drawings issued are for planning application purposes only.
2. Drawings not to be used for construction/contract conditions.
3. Copyright, all rights reserved. No part herewith may be copied or reproduced partially or wholly in any form whatsoever without the prior notice of the copyright owner McCarthy Keville O'Sullivan.
4. Do not scale off this drawing. Figured metric dimensions only should be taken off this drawing.
5. All contractors, whether main or sub-contractors, must visit the site and are responsible for taking and checking any and all dimensions and levels that relate to the works.
6. The use of or reliance upon this drawing shall be deemed to be acceptance of these conditions of use unless otherwise agreed in writing, such written agreement to be sought from and issued by the copyright holder to the use or reliance upon this drawing.
7. Layout plans show typical Turbine rotor diameter as per turbine drawing.
8. Final levels may vary depending on local ground conditions.
9. Exact location of cable/joint bay in the road corridor to be subject to ESB specifications and agreement with Westmeath County Council

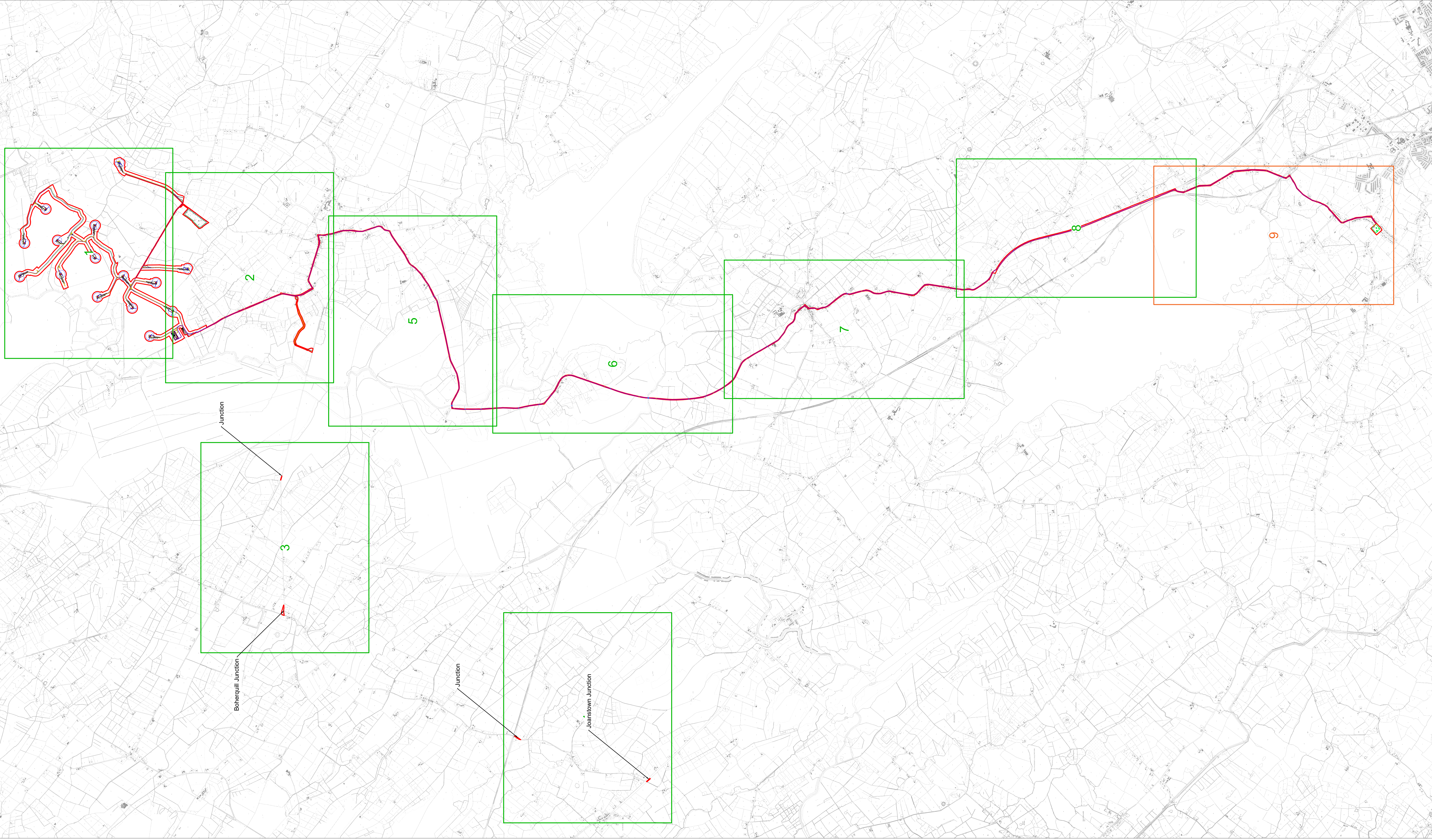

Drawing Legend

- Planning Application Boundary
- Existing Internal Road to be Upgraded
- Existing External Road to be Upgraded
- Proposed Road
- Crane Pad Hardstanding Area
- Turbine Foundation
- Turbine Sweep Area
- Borrow Pit
- Temporary Construction Compound
- Internal Electrical Cabling
- Grid Connection Route
- Proposed Cable Alteration
- Wind Farm Substation
- Existing Mullingar Substation

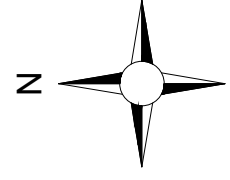

Site Location Key Plan

DRAWING TITLE
Coolle Wind Farm FI, Co. Westmeath

PROJECT TITLE	Coolle Wind Farm FI, Co. Westmeath
DRAWING BY	Joseph O'Brien
CHECKED BY	Meabhann Crowe
PROJECT NO.	200445g
DRAWING NO.	200445g - 03 FI
SCALE	1:30,000 @ A1
DATE	27.10.2022

OS SHEET No. 1: 2400, 2401, 2402, 2403, 2404, 2405, 2406, 2407, 2408, 2409, 2410, 2411, 2412, 2413, 2414, 2415, 2416, 2417, 2418, 2419, 2420, 2421, 2422, 2423, 2424, 2425, 2426, 2427, 2428, 2429, 2430, 2431, 2432, 2433, 2434, 2435, 2436, 2437, 2438, 2439, 2440, 2441, 2442, 2443, 2444, 2445, 2446, 2447, 2448, 2449, 2450, 2451, 2452, 2453, 2454, 2455, 2456, 2457, 2458, 2459, 2460, 2461, 2462, 2463, 2464, 2465, 2466, 2467, 2468, 2469, 2470, 2471, 2472, 2473, 2474, 2475, 2476, 2477, 2478, 2479, 2480, 2481, 2482, 2483, 2484, 2485, 2486, 2487, 2488, 2489, 2490, 2491, 2492, 2493, 2494, 2495, 2496, 2497, 2498, 2499, 2500, 2501, 2502, 2503, 2504, 2505, 2506, 2507, 2508, 2509, 2510, 2511, 2512, 2513, 2514, 2515, 2516, 2517, 2518, 2519, 2520, 2521, 2522, 2523, 2524, 2525, 2526, 2527, 2528, 2529, 2530, 2531, 2532, 2533, 2534, 2535, 2536, 2537, 2538, 2539, 2540, 2541, 2542, 2543, 2544, 2545, 2546, 2547, 2548, 2549, 2550, 2551, 2552, 2553, 2554, 2555, 2556, 2557, 2558, 2559, 2560, 2561, 2562, 2563, 2564, 2565, 2566, 2567, 2568, 2569, 2570, 2571, 2572, 2573, 2574, 2575, 2576, 2577, 2578, 2579, 2580, 2581, 2582, 2583, 2584, 2585, 2586, 2587, 2588, 2589, 2590, 2591, 2592, 2593, 2594, 2595, 2596, 2597, 2598, 2599, 2600, 2601, 2602, 2603, 2604, 2605, 2606, 2607, 2608, 2609, 2610, 2611, 2612, 2613, 2614, 2615, 2616, 2617, 2618, 2619, 2620, 2621, 2622, 2623, 2624, 2625, 2626, 2627, 2628, 2629, 2630, 2631, 2632, 2633, 2634, 2635, 2636, 2637, 2638, 2639, 2640, 2641, 2642, 2643, 2644, 2645, 2646, 2647, 2648, 2649, 2650, 2651, 2652, 2653, 2654, 2655, 2656, 2657, 2658, 2659, 2660, 2661, 2662, 2663, 2664, 2665, 2666, 2667, 2668, 2669, 2670, 2671, 2672, 2673, 2674, 2675, 2676, 2677, 2678, 2679, 2680, 2681, 2682, 2683, 2684, 2685, 2686, 2687, 2688, 2689, 2690, 2691, 2692, 2693, 2694, 2695, 2696, 2697, 2698, 2699, 2700, 2701, 2702, 2703, 2704, 2705, 2706, 2707, 2708, 2709, 2710, 2711, 2712, 2713, 2714, 2715, 2716, 2717, 2718, 2719, 2720, 2721, 2722, 2723, 2724, 2725, 2726, 2727, 2728, 2729, 2730, 2731, 2732, 2733, 2734, 2735, 2736, 2737, 2738, 2739, 2740, 2741, 2742, 2743, 2744, 2745, 2746, 2747, 2748, 2749, 2750, 2751, 2752, 2753, 2754, 2755, 2756, 2757, 2758, 2759, 2760, 2761, 2762, 2763, 2764, 2765, 2766, 2767, 2768, 2769, 2770, 2771, 2772, 2773, 2774, 2775, 2776, 2777, 2778, 2779, 2780, 2781, 2782, 2783, 2784, 2785, 2786, 2787, 2788, 2789, 2790, 2791, 2792, 2793, 2794, 2795, 2796, 2797, 2798, 2799, 2800, 2801, 2802, 2803, 2804, 2805, 2806, 2807, 2808, 2809, 2810, 2811, 2812, 2813, 2814, 2815, 2816, 2817, 2818, 2819, 2820, 2821, 2822, 2823, 2824, 2825, 2826, 2827, 2828, 2829, 2830, 2831, 2832, 2833, 2834, 2835, 2836, 2837, 2838, 2839, 2840, 2841, 2842, 2843, 2844, 2845, 2846, 2847, 2848, 2849, 2850, 2851, 2852, 2853, 2854, 2855, 2856, 2857, 2858, 2859, 2860, 2861, 2862, 2863, 2864, 2865, 2866, 2867, 2868, 2869, 2870, 2871, 2872, 2873, 2874, 2875, 2876, 2877, 2878, 2879, 2880, 2881, 2882, 2883, 2884, 2885, 2886, 2887, 2888, 2889, 2890, 2891, 2892, 2893, 2894, 2895, 2896, 2897, 2898, 2899, 2900, 2901, 2902, 2903, 2904, 2905, 2906, 2907, 2908, 2909, 2910, 2911, 2912, 2913, 2914, 2915, 2916, 2917, 2918, 2919, 2920, 2921, 2922, 2923, 2924, 2925, 2926, 2927, 2928, 2929, 2930, 2931, 2932, 2933, 2934, 2935, 2936, 2937, 2938, 2939, 2940, 2941, 2942, 2943, 2944, 2945, 2946, 2947, 2948, 2949, 2950, 2951, 2952, 2953, 2954, 2955, 2956, 2957, 2958, 2959, 2960, 2961, 2962, 2963, 2964, 2965, 2966, 2967, 2968, 2969, 2970, 2971, 2972, 2973, 2974, 2975, 2976, 2977, 2978, 2979, 2980, 2981, 2982, 2983, 2984, 2985, 2986, 2987, 2988, 2989, 2990, 2991, 2992, 2993, 2994, 2995, 2996, 2997, 2998, 2999, 3000, 3001, 3002, 3003, 3004, 3005, 3006, 3007, 3008, 3009, 3010, 3011, 3012, 3013, 3014, 3015, 3016, 3017, 3018, 3019, 3020, 3021, 3022, 3023, 3024, 3025, 3026, 3027, 3028, 3029, 3030, 3031, 3032, 3033, 3034, 3035, 3036, 3037, 3038, 3039, 3040, 3041, 3042, 3043, 3044, 3045, 3046, 3047, 3048, 3049, 3050, 3051, 3052, 3053, 3054, 3055, 3056, 3057, 3058, 3059, 3060, 3061, 3062, 3063, 3064, 3065, 3066, 3067, 3068, 3069, 3070, 3071, 3072, 3073, 3074, 3075, 3076, 3077, 3078, 3079, 3080, 3081, 3082, 3083, 3084, 3085, 3086, 3087, 3088, 3089, 3090, 3091, 3092, 3093, 3094, 3095, 3096, 3097, 3098, 3099, 3100, 3101, 3102, 3103, 3104, 3105, 3106, 3107, 3108, 3109, 3110, 3111, 3112, 3113, 3114, 3115, 3116, 3117, 3118, 3119, 3120, 3121, 3122, 3123, 3124, 3125, 3126, 3127, 3128, 3129, 3130, 3131, 3132, 3133, 3134, 3135, 3136, 3137, 3138, 3139, 3140, 3141, 3142, 3143, 3144, 3145, 3146, 3147, 3148, 3149, 3150, 3151, 3152, 3153, 3154, 3155, 3156, 3157, 3158, 3159, 3160, 3161, 3162, 3163, 3164, 3165, 3166, 3167, 3168, 3169, 3170, 3171, 3172, 3173, 3174, 3175, 3176, 3177, 3178, 3179, 3180, 3181, 3182, 3183, 3184, 3185, 3186, 3187, 3188, 3189, 3190, 3191, 3192, 3193, 3194, 3195, 3196, 3197, 3198, 3199, 3200, 3201, 3202, 3203, 3204, 3205, 3206, 3207, 3208, 3209, 3210, 3211, 3212, 3213, 3214, 3215, 3216, 3217, 3218, 3219, 3220, 3221, 3222, 3223, 3224, 3225, 3226, 3227, 3228, 3229, 3230, 3231, 3232, 3233, 3234, 3235, 3236, 3237, 3238, 3239, 3240, 3241, 3242, 3243, 3244, 3245, 3246, 3247, 3248, 3249, 3250, 3251, 3252, 3253, 3254, 3255, 3256, 3257, 3258, 3259, 3260, 3261, 3262, 3263, 3264, 3265, 3266, 3267, 3268, 3269, 3270, 3271, 3272, 3273, 3274, 3275, 3276, 3277, 3278, 3279, 3280, 3281, 3282, 3283, 3284, 3285, 3286, 3287, 3288, 3289, 3290, 3291, 3292, 3293, 3294, 3295, 3296, 3297, 3298, 3299, 3300, 3301, 3302, 3303, 3304, 3305, 3306, 3307, 3308, 3309, 3310, 3311, 3312, 3313, 3314, 3315, 3316, 3317, 3318, 3319, 3320, 3321, 3322, 3323, 3324, 3325, 3326, 3327, 3328, 3329, 3330, 3331, 3332, 3333, 3334, 3335, 3336, 3337, 3338, 3339, 3340, 3341, 3342, 3343, 3344, 3345, 3346, 3347, 3348, 3349, 3350, 3351, 3352, 3353, 3354, 3355, 3356, 3357, 3358, 3359, 3360, 3361, 3362, 3363, 3364, 3365, 3366, 3367, 3368, 3369, 3370, 3371, 3372, 3373, 3374, 3375, 3376, 3377, 3378, 3379, 3380, 3381, 3382, 3383, 3384, 3385, 3386, 3387, 3388, 3389, 3390, 3391, 3392, 3393, 3394, 3395, 3396, 3397, 3398, 3399, 3400, 3401, 3402, 3403, 3404, 3405, 3406, 3407, 3408, 3409, 3410, 3411, 3412, 3413, 3414, 3415, 3416, 3417, 3418, 3419, 3420, 3421, 3422, 3423, 3424, 3425, 3426, 3427, 3428, 3429, 3430, 3431, 3432, 3433, 3434, 3435, 3436, 3437, 3438, 3439, 3440, 3441, 3442, 3443, 3444, 3445, 3446, 3447, 3448, 3449, 3450, 3451, 3452, 3453, 3454, 3455, 3456, 3457, 3458, 3459, 3460, 3461, 3462, 3463, 3464, 3465, 3466, 3467, 3468, 3469, 3470, 3471, 3472, 3473, 3474, 3475, 3476, 3477, 3478, 3479, 3480, 3481, 3482, 3483, 3484, 3485, 3486, 3487, 3488, 3489, 3490, 3491, 3492, 3493, 3494, 3495, 3496, 3497, 3498, 3499, 3500, 3501, 3502, 3503, 3504, 3505, 3506, 3507, 3508, 3509, 3510, 3511, 3512, 3513, 3514, 3515, 3516, 3517, 3518, 3519, 3520, 3521, 3522, 3523, 3524, 3525, 3526, 3527, 3528, 3529, 3530, 3531, 3532, 3533, 3534, 3535, 3536, 3537, 3538, 3539, 3540, 3541, 3542, 3543, 3544, 3545, 3546, 3547, 3548, 3549, 3550, 3551, 3552, 3553, 3554, 3555, 3556, 3557, 3558, 3559, 3560, 3561, 3562, 3563, 3564, 3565, 3566, 3567, 3568, 3569, 3570, 3571, 3572, 3573, 3574, 3575, 3576, 3577, 3578, 3579, 3580, 3581, 3582, 3583, 3584, 3585, 3586, 3587, 3588, 3589, 3590, 3591, 3592, 3593, 3594, 3595, 3596, 3597, 3598, 3599, 3600, 3601, 3602, 3603, 3604, 3605, 3606, 3607, 3608, 3609, 3610, 3611, 3612, 3613, 3614, 3615, 3616, 3617, 3618, 3619, 3620, 3621, 3622, 3623, 3624, 3625, 3626, 3627, 3628, 3629, 3630, 3631, 3632, 3633, 3634, 3635, 3636, 3637, 3638, 3639, 3640, 3641, 3642, 3643, 3644, 3645, 3646, 3647, 3648, 3649, 3650, 3651, 3652, 3653, 3654, 3655, 3656, 3657, 3658, 3659, 3660, 3661, 3662, 3663, 3664, 3665, 3666, 3667, 3668, 3669, 3670, 3671, 3672, 3673, 3674, 3675, 3676, 3677, 3678, 3679, 3680, 3681, 3682, 3683, 3684, 3685, 3686, 3687, 3688, 3689, 3690, 3691, 3692, 3693, 3694, 3695, 3696, 3697, 3698, 3699, 3700, 3701, 3702, 3703, 3704, 3705, 3706, 3707, 3708, 3709, 3710, 3711, 3712, 3713, 3714, 3715, 3716, 3717, 3718, 3719, 3720, 3721, 3722, 3723, 3724, 3725, 3726, 3727, 3728, 3729, 3730, 3731, 3732, 3733, 3734, 3735, 3736, 3737, 3738, 3739, 3740, 3741, 3742, 3743, 3744, 3745, 3746, 3747, 3748, 3749, 3750, 3751, 3752, 3753, 3754, 3755, 3756, 3757, 3758, 3759, 3760, 3761, 3762, 3763, 3764, 3765, 3766, 3767, 3768, 3769, 3770, 3771, 3772, 3773, 3774, 3775, 3776, 3777, 3778, 3779, 3780, 3781, 3782, 3783, 3784, 3785, 3786, 3787, 3788, 3789, 3790, 3791, 3792, 3793, 3794, 3795, 3796, 3797, 3798, 3799, 3800, 3801, 3802, 3803, 3804, 3805, 3806, 3807, 3808, 3809, 3810, 3811, 3812, 3813, 3814, 3815, 3816, 3817, 3818, 3819, 3820, 3821, 3822, 3823, 3824, 3825, 3826, 3827, 3828, 3829, 3830, 3831, 3832, 3833, 3834, 3835, 3836, 3837, 3838, 3839, 3840, 3841, 3842, 3843, 3844, 3845, 3846, 3847, 3848, 3849, 3850, 3851, 3852, 3853, 3854, 3855, 3856, 3857, 3858, 3859, 3860, 3861, 3862, 3863, 3864, 3865, 3866, 3867, 3868, 3869, 3870, 3871, 3872, 3873, 3874, 3875, 3876, 3877, 3878, 3879, 3880, 3881, 3882, 3883, 3884, 3885, 3886, 3887, 3888, 3889, 3890, 3891, 3892, 3893, 3894, 3895, 3896, 3897, 3898, 3899, 3900, 3901, 3902, 3903, 3904, 3905, 3906, 3907, 3908, 3909, 3910, 3911, 3912, 3913, 3914, 3915, 3916, 3917, 3918, 3919, 3920, 3921, 3922, 3923, 3924, 3925, 3926, 3927, 3928, 3929, 3930, 3931, 3932, 3933, 3934, 3935, 3936, 3937, 3938, 3939, 3940, 3941, 3942, 3943, 3944, 3945, 3946, 3947, 3948, 3949, 3950, 3951, 3952, 3953, 3954, 3955, 3956, 3957, 3958, 3959, 3960, 3961, 3962, 3963, 3964, 3965, 3966, 3967, 3968, 3969, 3970, 3971, 3972, 3973, 3974, 3975, 3976, 3977, 3978, 3979, 3980, 3981, 3982, 3983, 3984, 3985, 3986, 3987, 3988, 3989, 3990, 3991, 3992, 3993, 3994, 3995, 3996, 3997, 3998, 3999, 4000, 4001, 4002, 4003, 4004, 4005, 4006, 4007, 4008, 4009, 4010, 4011, 4012, 4013, 4014, 4015, 4016, 4017, 4018, 4019, 4020, 4021, 4022, 4023, 4024, 4025, 4026, 4027, 4028, 4029, 4030, 4031, 4032, 4033, 4034, 4035, 4036, 4037, 4038, 4039, 4040, 4041, 4042, 4043, 4044, 4045, 4046, 4047, 4048, 4049, 4050, 4051, 4052, 4053, 4054, 4055, 4056, 4057, 4058, 4059, 4060, 4061, 4062, 4063, 4064, 4065, 4066, 4067, 4068, 4069, 4070, 4071, 4072, 4073, 4074, 4075, 4076, 4077, 4078, 4079, 4080, 4081, 4082, 4083, 4084, 4085, 4086, 4087, 4088, 4089, 4090, 4091, 4092, 4093, 4094, 4095, 4096, 4097, 4098, 4099, 4100, 4101, 4102, 4103, 4104, 4105, 4106, 4107, 4108, 4109, 4110, 4111, 4112, 4113, 4114, 4115, 4116, 4117, 4118, 4119, 4120, 4121, 4122, 4123, 4124, 4125, 4126, 4127, 4128, 4129, 4130, 4131, 4132, 4133, 4134, 4135, 4136, 4137, 4138, 4139, 4140, 4141, 4142, 4143, 4144, 4145, 4146, 4147, 4148, 4149, 4150, 4151, 4152, 4153, 4154, 4155, 4156, 4157, 4158, 4159, 4160, 4161, 4162, 4163, 4164, 4165, 4166, 4167, 4168, 4169, 4170, 4171, 4172, 4173, 4174, 4175, 4176, 4177, 4178, 4179, 4180, 4181, 4182, 4183, 4184, 4185, 4186, 4187, 4188, 4189, 4190, 4191, 4192, 4193, 4194, 4195, 4196, 4197, 4198, 4199, 4200, 4201, 4202, 4203, 4204, 4205, 4206, 4207, 4208, 4209, 4210, 4211, 4212, 4213, 4214, 4215, 4216, 4217, 4218, 4219, 4220, 4221, 4222, 4223, 4224, 4225, 4226, 4227, 4228, 4229, 4230, 4231, 4232, 4233, 4234, 4235, 4236, 4237, 4238, 4239, 4240, 4241, 4242, 4243, 4244, 4245, 4246, 4247, 4248, 4249, 4250, 4251, 4252, 4253, 4254, 4255, 4256, 4257, 4258, 4259, 4260, 4261, 4262, 4263, 4264, 4265, 4266, 4267, 4268, 4269, 4270, 4271, 4272, 4273, 4274, 4275, 4276, 4277, 4278, 4279, 4280, 4281, 4282, 4283, 4284, 4285, 4286, 4287, 4288, 4289, 4290, 4291, 4292, 4293,

- Project Design Drawing Notes**
1. Drawings issued are for planning application purposes only.
 2. Drawings not to be used for construction/contract conditions.
 3. Copyright, all rights reserved. No part herewith may be copied or reproduced partially or wholly in any form whatsoever without the prior notice of the copyright owner McCarthy Keville O'Sullivan.
 4. Do not scale off this drawing. Figured metric dimensions only should be taken off this drawing.
 5. All contractors, whether main or sub-contractors, must visit the site and are responsible for taking and checking any and all dimensions and levels that relate to the works.
 6. The use of or reliance upon this drawing shall be deemed to be acceptance of these conditions of use unless otherwise agreed in writing, such written agreement to be sought from and issued by the copyright holder to the use or reliance upon this drawing.
 7. Layout plans show typical Turbine rotor diameter as per turbine drawing.
 8. Final levels may vary depending on local ground conditions.
 9. Exact location of cable/joint bay in the road corridor to be subject to ESB specifications and agreement with Westmeath County Council

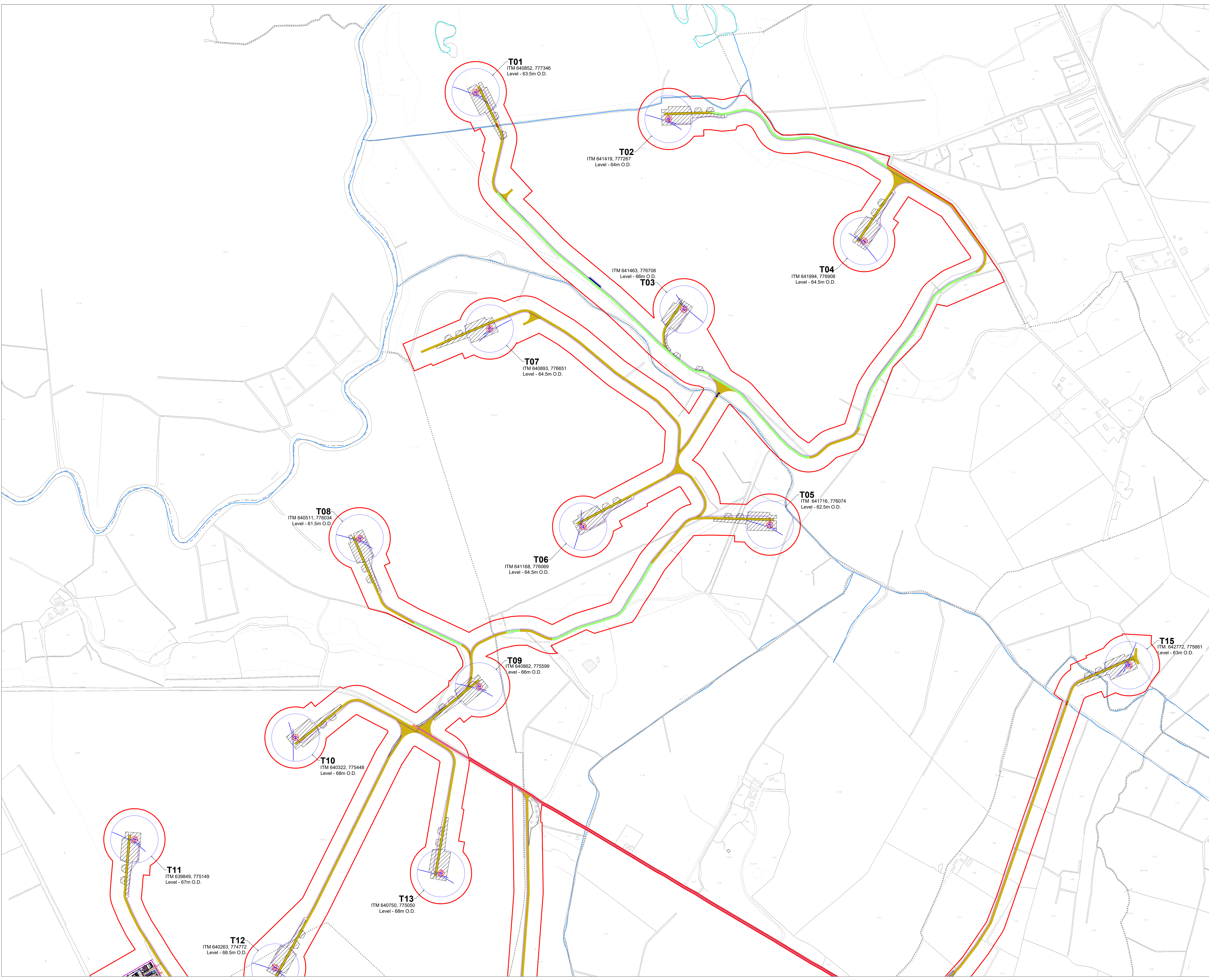

- Drawing Legend**
- Planning Application Boundary
 - Existing Internal Road to be Upgraded
 - Existing External Road to be Upgraded
 - Proposed Road
 - Proposed New Crossing
 - Existing Crossing for Upgrade
 - Passing Bays
 - Unbound Hardcore Surface
 - Crane Pad Hardstanding Area
 - Turbine Foundation
 - Turbine Sweep Area
 - Temporary Construction Compound
 - Internal Electrical Cabling
 - Wind Farm Substation
 - River/Stream
 - Lakes

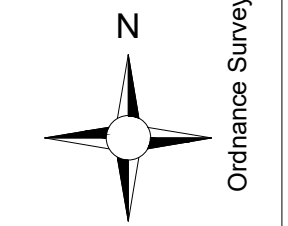

Site Location Plan
Sheet 1 of 9

PROJECT TITLE:
Coole Wind Farm FI, Co. Westmeath

DRAWING BY: **Joseph O'Brien** CHECKED BY: **Meabhann Crowe**
 PROJECT No.: **200445g** DRAWING No.: **200445g - 04 FI**

SCALE: **1:5,000 @ A1** DATE: **27.10.2022**

OS SHEET No.: 2494, 2495, 2496, 2497, 2498, 2499, 2500, 2501, 2502, 2503, 2504, 2505, 2506, 2507, 2508, 2509, 2510, 2511, 2512, 2513, 2514, 2515, 2516, 2517, 2518, 2519, 2520, 2521, 2522, 2523, 2524, 2525, 2526, 2527, 2528, 2529, 2530, 2531, 2532, 2533, 2534, 2535, 2536, 2537, 2538, 2539, 2540, 2541, 2542, 2543, 2544, 2545, 2546, 2547, 2548, 2549, 2550, 2551, 2552, 2553, 2554, 2555, 2556, 2557, 2558, 2559, 2560, 2561, 2562, 2563, 2564, 2565, 2566, 2567, 2568, 2569, 2570, 2571, 2572, 2573, 2574, 2575, 2576, 2577, 2578, 2579, 2580, 2581, 2582, 2583, 2584, 2585, 2586, 2587, 2588, 2589, 2590, 2591, 2592, 2593, 2594, 2595, 2596, 2597, 2598, 2599, 2600, 2601, 2602, 2603, 2604, 2605, 2606, 2607, 2608, 2609, 2610, 2611, 2612, 2613, 2614, 2615, 2616, 2617, 2618, 2619, 2620, 2621, 2622, 2623, 2624, 2625, 2626, 2627, 2628, 2629, 2630, 2631, 2632, 2633, 2634, 2635, 2636, 2637, 2638, 2639, 2640, 2641, 2642, 2643, 2644, 2645, 2646, 2647, 2648, 2649, 2650, 2651, 2652, 2653, 2654, 2655, 2656, 2657, 2658, 2659, 2660, 2661, 2662, 2663, 2664, 2665, 2666, 2667, 2668, 2669, 2670, 2671, 2672, 2673, 2674, 2675, 2676, 2677, 2678, 2679, 2680, 2681, 2682, 2683, 2684, 2685, 2686, 2687, 2688, 2689, 2690, 2691, 2692, 2693, 2694, 2695, 2696, 2697, 2698, 2699, 2700, 2701, 2702, 2703, 2704, 2705, 2706, 2707, 2708, 2709, 2710, 2711, 2712, 2713, 2714, 2715, 2716, 2717, 2718, 2719, 2720, 2721, 2722, 2723, 2724, 2725, 2726, 2727, 2728, 2729, 2730, 2731, 2732, 2733, 2734, 2735, 2736, 2737, 2738, 2739, 2740, 2741, 2742, 2743, 2744, 2745, 2746, 2747, 2748, 2749, 2750, 2751, 2752, 2753, 2754, 2755, 2756, 2757, 2758, 2759, 2760, 2761, 2762, 2763, 2764, 2765, 2766, 2767, 2768, 2769, 2770, 2771, 2772, 2773, 2774, 2775, 2776, 2777, 2778, 2779, 2780, 2781, 2782, 2783, 2784, 2785, 2786, 2787, 2788, 2789, 2790, 2791, 2792, 2793, 2794, 2795, 2796, 2797, 2798, 2799, 2800, 2801, 2802, 2803, 2804, 2805, 2806, 2807, 2808, 2809, 2810, 2811, 2812, 2813, 2814, 2815, 2816, 2817, 2818, 2819, 2820, 2821, 2822, 2823, 2824, 2825, 2826, 2827, 2828, 2829, 2830, 2831, 2832, 2833, 2834, 2835, 2836, 2837, 2838, 2839, 2840, 2841, 2842, 2843, 2844, 2845, 2846, 2847, 2848, 2849, 2850, 2851, 2852, 2853, 2854, 2855, 2856, 2857, 2858, 2859, 2860, 2861, 2862, 2863, 2864, 2865, 2866, 2867, 2868, 2869, 2870, 2871, 2872, 2873, 2874, 2875, 2876, 2877, 2878, 2879, 2880, 2881, 2882, 2883, 2884, 2885, 2886, 2887, 2888, 2889, 2890, 2891, 2892, 2893, 2894, 2895, 2896, 2897, 2898, 2899, 2900, 2901, 2902, 2903, 2904, 2905, 2906, 2907, 2908, 2909, 2910, 2911, 2912, 2913, 2914, 2915, 2916, 2917, 2918, 2919, 2920, 2921, 2922, 2923, 2924, 2925, 2926, 2927, 2928, 2929, 2930, 2931, 2932, 2933, 2934, 2935, 2936, 2937, 2938, 2939, 2940, 2941, 2942, 2943, 2944, 2945, 2946, 2947, 2948, 2949, 2950, 2951, 2952, 2953, 2954, 2955, 2956, 2957, 2958, 2959, 2960, 2961, 2962, 2963, 2964, 2965, 2966, 2967, 2968, 2969, 2970, 2971, 2972, 2973, 2974, 2975, 2976, 2977, 2978, 2979, 2980, 2981, 2982, 2983, 2984, 2985, 2986, 2987, 2988, 2989, 2990, 2991, 2992, 2993, 2994, 2995, 2996, 2997, 2998, 2999, 3000, 3001, 3002, 3003, 3004, 3005, 3006, 3007, 3008, 3009, 3010, 3011, 3012, 3013, 3014, 3015, 3016, 3017, 3018, 3019, 3020, 3021, 3022, 3023, 3024, 3025, 3026, 3027, 3028, 3029, 3030, 3031, 3032, 3033, 3034, 3035, 3036, 3037, 3038, 3039, 3040, 3041, 3042, 3043, 3044, 3045, 3046, 3047, 3048, 3049, 3050, 3051, 3052, 3053, 3054, 3055, 3056, 3057, 3058, 3059, 3060, 3061, 3062, 3063, 3064, 3065, 3066, 3067, 3068, 3069, 3070, 3071, 3072, 3073, 3074, 3075, 3076, 3077, 3078, 3079, 3080, 3081, 3082, 3083, 3084, 3085, 3086, 3087, 3088, 3089, 3090, 3091, 3092, 3093, 3094, 3095, 3096, 3097, 3098, 3099, 3100, 3101, 3102, 3103, 3104, 3105, 3106, 3107, 3108, 3109, 3110, 3111, 3112, 3113, 3114, 3115, 3116, 3117, 3118, 3119, 3120, 3121, 3122, 3123, 3124, 3125, 3126, 3127, 3128, 3129, 3130, 3131, 3132, 3133, 3134, 3135, 3136, 3137, 3138, 3139, 3140, 3141, 3142, 3143, 3144, 3145, 3146, 3147, 3148, 3149, 3150, 3151, 3152, 3153, 3154, 3155, 3156, 3157, 3158, 3159, 3160, 3161, 3162, 3163, 3164, 3165, 3166, 3167, 3168, 3169, 3170, 3171, 3172, 3173, 3174, 3175, 3176, 3177, 3178, 3179, 3180, 3181, 3182, 3183, 3184, 3185, 3186, 3187, 3188, 3189, 3190, 3191, 3192, 3193, 3194, 3195, 3196, 3197, 3198, 3199, 3200, 3201, 3202, 3203, 3204, 3205, 3206, 3207, 3208, 3209, 3210, 3211, 3212, 3213, 3214, 3215, 3216, 3217, 3218, 3219, 3220, 3221, 3222, 3223, 3224, 3225, 3226, 3227, 3228, 3229, 3230, 3231, 3232, 3233, 3234, 3235, 3236, 3237, 3238, 3239, 3240, 3241, 3242, 3243, 3244, 3245, 3246, 3247, 3248, 3249, 3250, 3251, 3252, 3253, 3254, 3255, 3256, 3257, 3258, 3259, 3260, 3261, 3262, 3263, 3264, 3265, 3266, 3267, 3268, 3269, 3270, 3271, 3272, 3273, 3274, 3275, 3276, 3277, 3278, 3279, 3280, 3281, 3282, 3283, 3284, 3285, 3286, 3287, 3288, 3289, 3290, 3291, 3292, 3293, 3294, 3295, 3296, 3297, 3298, 3299, 3300, 3301, 3302, 3303, 3304, 3305, 3306, 3307, 3308, 3309, 3310, 3311, 3312, 3313, 3314, 3315, 3316, 3317, 3318, 3319, 3320, 3321, 3322, 3323, 3324, 3325, 3326, 3327, 3328, 3329, 3330, 3331, 3332, 3333, 3334, 3335, 3336, 3337, 3338, 3339, 3340, 3341, 3342, 3343, 3344, 3345, 3346, 3347, 3348, 3349, 3350, 3351, 3352, 3353, 3354, 3355, 3356, 3357, 3358, 3359, 3360, 3361, 3362, 3363, 3364, 3365, 3366, 3367, 3368, 3369, 3370, 3371, 3372, 3373, 3374, 3375, 3376, 3377, 3378, 3379, 3380, 3381, 3382, 3383, 3384, 3385, 3386, 3387, 3388, 3389, 3390, 3391, 3392, 3393, 3394, 3395, 3396, 3397, 3398, 3399, 3400, 3401, 3402, 3403, 3404, 3405, 3406, 3407, 3408, 3409, 3410, 3411, 3412, 3413, 3414, 3415, 3416, 3417, 3418, 3419, 3420, 3421, 3422, 3423, 3424, 3425, 3426, 3427, 3428, 3429, 3430, 3431, 3432, 3433, 3434, 3435, 3436, 3437, 3438, 3439, 3440, 3441, 3442, 3443, 3444, 3445, 3446, 3447, 3448, 3449, 3450, 3451, 3452, 3453, 3454, 3455, 3456, 3457, 3458, 3459, 3460, 3461, 3462, 3463, 3464, 3465, 3466, 3467, 3468, 3469, 3470, 3471, 3472, 3473, 3474, 3475, 3476, 3477, 3478, 3479, 3480, 3481, 3482, 3483, 3484, 3485, 3486, 3487, 3488, 3489, 3490, 3491, 3492, 3493, 3494, 3495, 3496, 3497, 3498, 3499, 3500, 3501, 3502, 3503, 3504, 3505, 3506, 3507, 3508, 3509, 3510, 3511, 3512, 3513, 3514, 3515, 3516, 3517, 3518, 3519, 3520, 3521, 3522, 3523, 3524, 3525, 3526, 3527, 3528, 3529, 3530, 3531, 3532, 3533, 3534, 3535, 3536, 3537, 3538, 3539, 3540, 3541, 3542, 3543, 3544, 3545, 3546, 3547, 3548, 3549, 3550, 3551, 3552, 3553, 3554, 3555, 3556, 3557, 3558, 3559, 3560, 3561, 3562, 3563, 3564, 3565, 3566, 3567, 3568, 3569, 3570, 3571, 3572, 3573, 3574, 3575, 3576, 3577, 3578, 3579, 3580, 3581, 3582, 3583, 3584, 3585, 3586, 3587, 3588, 3589, 3590, 3591, 3592, 3593, 3594, 3595, 3596, 3597, 3598, 3599, 3600, 3601, 3602, 3603, 3604, 3605, 3606, 3607, 3608, 3609, 3610, 3611, 3612, 3613, 3614, 3615, 3616, 3617, 3618, 3619, 3620, 3621, 3622, 3623, 3624, 3625, 3626, 3627, 3628, 3629, 3630, 3631, 3632, 3633, 3634, 3635, 3636, 3637, 3638, 3639, 3640, 3641, 3642, 3643, 3644, 3645, 3646, 3647, 3648, 3649, 3650, 3651, 3652, 3653, 3654, 3655, 3656, 3657, 3658, 3659, 3660, 3661, 3662, 3663, 3664, 3665, 3666, 3667, 3668, 3669, 3670, 3671, 3672, 3673, 3674, 3675, 3676, 3677, 3678, 3679, 3680, 3681, 3682, 3683, 3684, 3685, 3686, 3687, 3688, 3689, 3690, 3691, 3692, 3693, 3694, 3695, 3696, 3697, 3698, 3699, 3700, 3701, 3702, 3703, 3704, 3705, 3706, 3707, 3708, 3709, 3710, 3711, 3712, 3713, 3714, 3715, 3716, 3717, 3718, 3719, 3720, 3721, 3722, 3723, 3724, 3725, 3726, 3727, 3728, 3729, 3730, 3731, 3732, 3733, 3734, 3735, 3736, 3737, 3738, 3739, 3740, 3741, 3742, 3743, 3744, 3745, 3746, 3747, 3748, 3749, 3750, 3751, 3752, 3753, 3754, 3755, 3756, 3757, 3758, 3759, 3760, 3761, 3762, 3763, 3764, 3765, 3766, 3767, 3768, 3769, 3770, 3771, 3772, 3773, 3774, 3775, 3776, 3777, 3778, 3779, 3780, 3781, 3782, 3783, 3784, 3785, 3786, 3787, 3788, 3789, 3790, 3791, 3792, 3793, 3794, 3795, 3796, 3797, 3798, 3799, 3800, 3801, 3802, 3803, 3804, 3805, 3806, 3807, 3808, 3809, 3810, 3811, 3812, 3813, 3814, 3815, 3816, 3817, 3818, 3819, 3820, 3821, 3822, 3823, 3824, 3825, 3826, 3827, 3828, 3829, 3830, 3831, 3832, 3833, 3834, 3835, 3836, 3837, 3838, 3839, 3840, 3841, 3842, 3843, 3844, 3845, 3846, 3847, 3848, 3849, 3850, 3851, 3852, 3853, 3854, 3855, 3856, 3857, 3858, 3859, 3860, 3861, 3862, 3863, 3864, 3865, 3866, 3867, 3868, 3869, 3870, 3871, 3872, 3873, 3874, 3875, 3876, 3877, 3878, 3879, 3880, 3881, 3882, 3883, 3884, 3885, 3886, 3887, 3888, 3889, 3890, 3891, 3892, 3893, 3894, 3895, 3896, 3897, 3898, 3899, 3900, 3901, 3902, 3903, 3904, 3905, 3906, 3907, 3908, 3909, 3910, 3911, 3912, 3913, 3914, 3915, 3916, 3917, 3918, 3919, 3920, 3921, 3922, 3923, 3924, 3925, 3926, 3927, 3928, 3929, 3930, 3931, 3932, 3933, 3934, 3935, 3936, 3937, 3938, 3939, 3940, 3941, 3942, 3943, 3944, 3945, 3946, 3947, 3948, 3949, 3950, 3951, 3952, 3953, 3954, 3955, 3956, 3957, 3958, 3959, 3960, 3961, 3962, 3963, 3964, 3965, 3966, 3967, 3968, 3969, 3970, 3971, 3972, 3973, 3974, 3975, 3976, 3977, 3978, 3979, 3980, 3981, 3982, 3983, 3984, 3985, 3986, 3987, 3988, 3989, 3990, 3991, 3992, 3993, 3994, 3995, 3996, 3997, 3998, 3999, 4000, 4001, 4002, 4003, 4004, 4005, 4006, 4007, 4008, 4009, 4010, 4011, 4012, 4013, 4014, 4015, 4016, 4017, 4018, 4019, 4020, 4021, 4022, 4023, 4024, 4025, 4026, 4027, 4028, 4029, 4030, 4031, 4032, 4033, 4034, 4035, 4036, 4037, 4038, 4039, 4040, 4041, 4042, 4043, 4044, 4045, 4046, 4047, 4048, 4049, 4050, 4051, 4052, 4053, 4054, 4055, 4056, 4057, 4058, 4059, 4060, 4061, 4062, 4063, 4064, 4065, 4066, 4067, 4068, 4069, 4070, 4071, 4072, 4073, 4074, 4075, 4076, 4077, 4078, 4079, 4080, 4081, 4082, 4083, 4084, 4085, 4086, 4087, 4088, 4089, 4090, 4091, 4092, 4093, 4094, 4095, 4096, 4097, 4098, 4099, 4100, 4101, 4102, 4103, 4104, 4105, 4106, 4107, 4108, 4109, 4110, 4111, 4112, 4113, 4114, 4115, 4116, 4117, 4118, 4119, 4120, 4121, 4122, 4123, 4124, 4125, 4126, 4127, 4128, 4129, 4130, 4131, 4132, 4133, 4134, 4135, 4136, 4137, 4138, 4139, 4140, 4141, 4142, 4143, 4144, 4145, 4146, 4147, 4148, 4149, 4150, 4151, 4152, 4153, 4154, 4155, 4156, 4157, 4158, 4159, 4160, 4161, 4162, 4163, 4164, 4165, 4166, 4167, 4168, 4169, 4170, 4171, 4172, 4173, 4174, 4175, 4176, 4177, 4178, 4179, 4180, 4181, 4182, 4183, 4184, 4185, 4186, 4187, 4188, 4189, 4190, 4191, 4192, 4193, 4194, 4195, 4196, 4197, 4198, 4199, 4200, 4201, 4202, 4203, 4204, 4205, 4206, 4207, 4208, 4209, 4210, 4211, 4212, 4213, 4214, 4215, 4216, 4217, 4218, 4219, 4220, 4221, 4222, 4223, 4224, 4225, 4226, 4227, 4228, 4229, 4230, 4231, 4232, 4233, 4234, 4235, 4236, 4237, 4238, 4239, 4240, 4241, 4242, 4243, 4244, 4245, 4246, 4247, 4248, 4249, 4250, 4251, 4252, 4253, 4254, 4255, 4256, 4257, 4258, 4259, 4260, 4261, 4262, 4263, 4264, 4265, 4266, 4267, 4268, 4269, 4270, 4271, 4272, 4273, 4274, 4275, 4276, 4277, 4278, 4279, 4280, 4281, 4282, 4283, 4284, 4285, 4286, 4287, 4288, 4289, 4290, 4291, 4292, 4293, 4294, 4295, 4296, 4297, 4298, 4299, 4300, 4301, 4302, 4303, 4304, 4305, 4306, 4307, 4308, 4309, 4310, 4311, 4312, 4313, 4314, 4315, 4316, 4317, 4318, 4319, 4320, 4321, 4322, 4323, 4324, 4325, 4326, 4327, 4328, 4329, 4330, 4331, 4332, 4333, 4334, 4335, 4336, 4337, 4338, 4339, 4340, 4341, 4342, 4343, 4344, 4345, 4346, 4347, 4348, 4349, 4350, 4351, 4352, 4353, 4354, 4355, 4356, 4357, 4358, 4359, 4360, 4361, 4362, 4363, 4364, 4365, 4366, 4367, 4368, 4369, 4370, 4371, 4372, 4373, 4374, 4375, 4376, 4377, 4378, 4379, 4380, 4381, 4382, 4383, 4384, 4385, 4386, 4387, 4388, 4389, 4390, 4391, 4392, 4393, 4394, 4395, 4396, 4397, 4398, 4399, 4400, 4

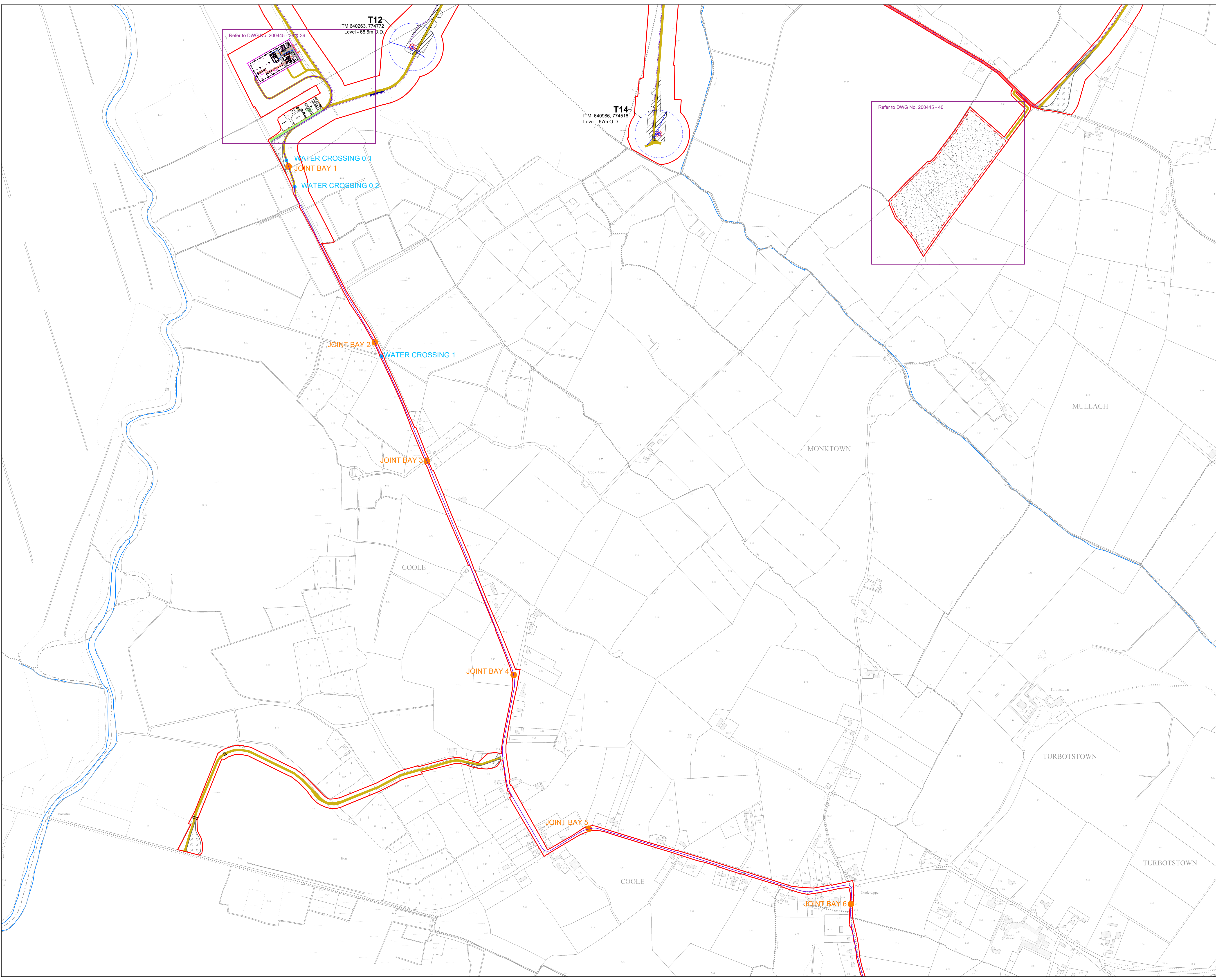

- Project Design Drawing Notes**
1. Drawings issued are for planning application purposes only.
 2. Drawings not to be used for construction/contract conditions.
 3. Copyright, all rights reserved. No part herewith may be copied or reproduced partially or wholly in any form whatsoever without the prior notice of the copyright owner McCarthy Keville O'Sullivan.
 4. Do not scale off this drawing. Figured metric dimensions only should be taken off this drawing.
 5. All contractors, whether main or sub-contractors, must visit the site and are responsible for taking and checking any and all dimensions and levels that relate to the works.
 6. The use of or reliance upon this drawing shall be deemed to be acceptance of these conditions of use unless otherwise agreed in writing, such written agreement to be sought from and issued by the copyright holder to the use or reliance upon this drawing.
 7. Layout plans show typical Turbine rotor diameter as per turbine drawing.
 8. Final levels may vary depending on local ground conditions.
 9. Exact location of cable/joint bay in the road corridor to be subject to ESB specifications and agreement with Westmeath County Council

Drawing Legend

- Planning Application Boundary
- Existing Internal Road to be Upgraded
- Existing External Road to be Upgraded
- Proposed Road
- Proposed New Crossing
- Passing Bays
- Unbound Hardcore Surface
- Crossing Point for Landowners
- Crane Pad Hardstanding Area
- Turbine Foundation
- Turbine Sweep Area
- Borrow Pit
- Internal Electrical Cabling
- Grid Connection Route
- Wind Farm Substation
- Joint Bay
- Watercrossing
- River/Stream

**Site Location Plan
Sheet 2 of 9**

PROJECT TITLE:
Coole Wind Farm FI, Co. Westmeath

DRAWING BY: **Joseph O'Brien** CHECKED BY: **Meabhann Crowe**

PROJECT No.: **200445g** DRAWING No.: **200445g - 05 FI**

SCALE: **1:5,000 @ A1** DATE: **27.10.2022**

OS SHEET No.: 2494, 2495, 2496, 2497, 2498, 2499, 2500, 2501, 2502, 2503, 2504, 2505, 2506, 2507, 2508, 2509, 2510, 2511, 2512, 2513, 2514, 2515, 2516, 2517, 2518, 2519, 2520, 2521, 2522, 2523, 2524, 2525, 2526, 2527, 2528, 2529, 2530, 2531, 2532, 2533, 2534, 2535, 2536, 2537, 2538, 2539, 2540, 2541, 2542, 2543, 2544, 2545, 2546, 2547, 2548, 2549, 2550, 2551, 2552, 2553, 2554, 2555, 2556, 2557, 2558, 2559, 2560, 2561, 2562, 2563, 2564, 2565, 2566, 2567, 2568, 2569, 2570, 2571, 2572, 2573, 2574, 2575, 2576, 2577, 2578, 2579, 2580, 2581, 2582, 2583, 2584, 2585, 2586, 2587, 2588, 2589, 2590, 2591, 2592, 2593, 2594, 2595, 2596, 2597, 2598, 2599, 2600, 2601, 2602, 2603, 2604, 2605, 2606, 2607, 2608, 2609, 2610, 2611, 2612, 2613, 2614, 2615, 2616, 2617, 2618, 2619, 2620, 2621, 2622, 2623, 2624, 2625, 2626, 2627, 2628, 2629, 2630, 2631, 2632, 2633, 2634, 2635, 2636, 2637, 2638, 2639, 2640, 2641, 2642, 2643, 2644, 2645, 2646, 2647, 2648, 2649, 2650, 2651, 2652, 2653, 2654, 2655, 2656, 2657, 2658, 2659, 2660, 2661, 2662, 2663, 2664, 2665, 2666, 2667, 2668, 2669, 2670, 2671, 2672, 2673, 2674, 2675, 2676, 2677, 2678, 2679, 2680, 2681, 2682, 2683, 2684, 2685, 2686, 2687, 2688, 2689, 2690, 2691, 2692, 2693, 2694, 2695, 2696, 2697, 2698, 2699, 2700, 2701, 2702, 2703, 2704, 2705, 2706, 2707, 2708, 2709, 2710, 2711, 2712, 2713, 2714, 2715, 2716, 2717, 2718, 2719, 2720, 2721, 2722, 2723, 2724, 2725, 2726, 2727, 2728, 2729, 2730, 2731, 2732, 2733, 2734, 2735, 2736, 2737, 2738, 2739, 2740, 2741, 2742, 2743, 2744, 2745, 2746, 2747, 2748, 2749, 2750, 2751, 2752, 2753, 2754, 2755, 2756, 2757, 2758, 2759, 2760, 2761, 2762, 2763, 2764, 2765, 2766, 2767, 2768, 2769, 2770, 2771, 2772, 2773, 2774, 2775, 2776, 2777, 2778, 2779, 2780, 2781, 2782, 2783, 2784, 2785, 2786, 2787, 2788, 2789, 2790, 2791, 2792, 2793, 2794, 2795, 2796, 2797, 2798, 2799, 2800, 2801, 2802, 2803, 2804, 2805, 2806, 2807, 2808, 2809, 2810, 2811, 2812, 2813, 2814, 2815, 2816, 2817, 2818, 2819, 2820, 2821, 2822, 2823, 2824, 2825, 2826, 2827, 2828, 2829, 2830, 2831, 2832, 2833, 2834, 2835, 2836, 2837, 2838, 2839, 2840, 2841, 2842, 2843, 2844, 2845, 2846, 2847, 2848, 2849, 2850, 2851, 2852, 2853, 2854, 2855, 2856, 2857, 2858, 2859, 2860, 2861, 2862, 2863, 2864, 2865, 2866, 2867, 2868, 2869, 2870, 2871, 2872, 2873, 2874, 2875, 2876, 2877, 2878, 2879, 2880, 2881, 2882, 2883, 2884, 2885, 2886, 2887, 2888, 2889, 2890, 2891, 2892, 2893, 2894, 2895, 2896, 2897, 2898, 2899, 2900, 2901, 2902, 2903, 2904, 2905, 2906, 2907, 2908, 2909, 2910, 2911, 2912, 2913, 2914, 2915, 2916, 2917, 2918, 2919, 2920, 2921, 2922, 2923, 2924, 2925, 2926, 2927, 2928, 2929, 2930, 2931, 2932, 2933, 2934, 2935, 2936, 2937, 2938, 2939, 2940, 2941, 2942, 2943, 2944, 2945, 2946, 2947, 2948, 2949, 2950, 2951, 2952, 2953, 2954, 2955, 2956, 2957, 2958, 2959, 2960, 2961, 2962, 2963, 2964, 2965, 2966, 2967, 2968, 2969, 2970, 2971, 2972, 2973, 2974, 2975, 2976, 2977, 2978, 2979, 2980, 2981, 2982, 2983, 2984, 2985, 2986, 2987, 2988, 2989, 2990, 2991, 2992, 2993, 2994, 2995, 2996, 2997, 2998, 2999, 3000, 3001, 3002, 3003, 3004, 3005, 3006, 3007, 3008, 3009, 3010, 3011, 3012, 3013, 3014, 3015, 3016, 3017, 3018, 3019, 3020, 3021, 3022, 3023, 3024, 3025, 3026, 3027, 3028, 3029, 3030, 3031, 3032, 3033, 3034, 3035, 3036, 3037, 3038, 3039, 3040, 3041, 3042, 3043, 3044, 3045, 3046, 3047, 3048, 3049, 3050, 3051, 3052, 3053, 3054, 3055, 3056, 3057, 3058, 3059, 3060, 3061, 3062, 3063, 3064, 3065, 3066, 3067, 3068, 3069, 3070, 3071, 3072, 3073, 3074, 3075, 3076, 3077, 3078, 3079, 3080, 3081, 3082, 3083, 3084, 3085, 3086, 3087, 3088, 3089, 3090, 3091, 3092, 3093, 3094, 3095, 3096, 3097, 3098, 3099, 3100, 3101, 3102, 3103, 3104, 3105, 3106, 3107, 3108, 3109, 3110, 3111, 3112, 3113, 3114, 3115, 3116, 3117, 3118, 3119, 3120, 3121, 3122, 3123, 3124, 3125, 3126, 3127, 3128, 3129, 3130, 3131, 3132, 3133, 3134, 3135, 3136, 3137, 3138, 3139, 3140, 3141, 3142, 3143, 3144, 3145, 3146, 3147, 3148, 3149, 3150, 3151, 3152, 3153, 3154, 3155, 3156, 3157, 3158, 3159, 3160, 3161, 3162, 3163, 3164, 3165, 3166, 3167, 3168, 3169, 3170, 3171, 3172, 3173, 3174, 3175, 3176, 3177, 3178, 3179, 3180, 3181, 3182, 3183, 3184, 3185, 3186, 3187, 3188, 3189, 3190, 3191, 3192, 3193, 3194, 3195, 3196, 3197, 3198, 3199, 3200, 3201, 3202, 3203, 3204, 3205, 3206, 3207, 3208, 3209, 3210, 3211, 3212, 3213, 3214, 3215, 3216, 3217, 3218, 3219, 3220, 3221, 3222, 3223, 3224, 3225, 3226, 3227, 3228, 3229, 3230, 3231, 3232, 3233, 3234, 3235, 3236, 3237, 3238, 3239, 3240, 3241, 3242, 3243, 3244, 3245, 3246, 3247, 3248, 3249, 3250, 3251, 3252, 3253, 3254, 3255, 3256, 3257, 3258, 3259, 3260, 3261, 3262, 3263, 3264, 3265, 3266, 3267, 3268, 3269, 3270, 3271, 3272, 3273, 3274, 3275, 3276, 3277, 3278, 3279, 3280, 3281, 3282, 3283, 3284, 3285, 3286, 3287, 3288, 3289, 3290, 3291, 3292, 3293, 3294, 3295, 3296, 3297, 3298, 3299, 3300, 3301, 3302, 3303, 3304, 3305, 3306, 3307, 3308, 3309, 3310, 3311, 3312, 3313, 3314, 3315, 3316, 3317, 3318, 3319, 3320, 3321, 3322, 3323, 3324, 3325, 3326, 3327, 3328, 3329, 3330, 3331, 3332, 3333, 3334, 3335, 3336, 3337, 3338, 3339, 3340, 3341, 3342, 3343, 3344, 3345, 3346, 3347, 3348, 3349, 3350, 3351, 3352, 3353, 3354, 3355, 3356, 3357, 3358, 3359, 3360, 3361, 3362, 3363, 3364, 3365, 3366, 3367, 3368, 3369, 3370, 3371, 3372, 3373, 3374, 3375, 3376, 3377, 3378, 3379, 3380, 3381, 3382, 3383, 3384, 3385, 3386, 3387, 3388, 3389, 3390, 3391, 3392, 3393, 3394, 3395, 3396, 3397, 3398, 3399, 3400, 3401, 3402, 3403, 3404, 3405, 3406, 3407, 3408, 3409, 3410, 3411, 3412, 3413, 3414, 3415, 3416, 3417, 3418, 3419, 3420, 3421, 3422, 3423, 3424, 3425, 3426, 3427, 3428, 3429, 3430, 3431, 3432, 3433, 3434, 3435, 3436, 3437, 3438, 3439, 3440, 3441, 3442, 3443, 3444, 3445, 3446, 3447, 3448, 3449, 3450, 3451, 3452, 3453, 3454, 3455, 3456, 3457, 3458, 3459, 3460, 3461, 3462, 3463, 3464, 3465, 3466, 3467, 3468, 3469, 3470, 3471, 3472, 3473, 3474, 3475, 3476, 3477, 3478, 3479, 3480, 3481, 3482, 3483, 3484, 3485, 3486, 3487, 3488, 3489, 3490, 3491, 3492, 3493, 3494, 3495, 3496, 3497, 3498, 3499, 3500, 3501, 3502, 3503, 3504, 3505, 3506, 3507, 3508, 3509, 3510, 3511, 3512, 3513, 3514, 3515, 3516, 3517, 3518, 3519, 3520, 3521, 3522, 3523, 3524, 3525, 3526, 3527, 3528, 3529, 3530, 3531, 3532, 3533, 3534, 3535, 3536, 3537, 3538, 3539, 3540, 3541, 3542, 3543, 3544, 3545, 3546, 3547, 3548, 3549, 3550, 3551, 3552, 3553, 3554, 3555, 3556, 3557, 3558, 3559, 3560, 3561, 3562, 3563, 3564, 3565, 3566, 3567, 3568, 3569, 3570, 3571, 3572, 3573, 3574, 3575, 3576, 3577, 3578, 3579, 3580, 3581, 3582, 3583, 3584, 3585, 3586, 3587, 3588, 3589, 3590, 3591, 3592, 3593, 3594, 3595, 3596, 3597, 3598, 3599, 3600, 3601, 3602, 3603, 3604, 3605, 3606, 3607, 3608, 3609, 3610, 3611, 3612, 3613, 3614, 3615, 3616, 3617, 3618, 3619, 3620, 3621, 3622, 3623, 3624, 3625, 3626, 3627, 3628, 3629, 3630, 3631, 3632, 3633, 3634, 3635, 3636, 3637, 3638, 3639, 3640, 3641, 3642, 3643, 3644, 3645, 3646, 3647, 3648, 3649, 3650, 3651, 3652, 3653, 3654, 3655, 3656, 3657, 3658, 3659, 3660, 3661, 3662, 3663, 3664, 3665, 3666, 3667, 3668, 3669, 3670, 3671, 3672, 3673, 3674, 3675, 3676, 3677, 3678, 3679, 3680, 3681, 3682, 3683, 3684, 3685, 3686, 3687, 3688, 3689, 3690, 3691, 3692, 3693, 3694, 3695, 3696, 3697, 3698, 3699, 3700, 3701, 3702, 3703, 3704, 3705, 3706, 3707, 3708, 3709, 3710, 3711, 3712, 3713, 3714, 3715, 3716, 3717, 3718, 3719, 3720, 3721, 3722, 3723, 3724, 3725, 3726, 3727, 3728, 3729, 3730, 3731, 3732, 3733, 3734, 3735, 3736, 3737, 3738, 3739, 3740, 3741, 3742, 3743, 3744, 3745, 3746, 3747, 3748, 3749, 3750, 3751, 3752, 3753, 3754, 3755, 3756, 3757, 3758, 3759, 3760, 3761, 3762, 3763, 3764, 3765, 3766, 3767, 3768, 3769, 3770, 3771, 3772, 3773, 3774, 3775, 3776, 3777, 3778, 3779, 3780, 3781, 3782, 3783, 3784, 3785, 3786, 3787, 3788, 3789, 3790, 3791, 3792, 3793, 3794, 3795, 3796, 3797, 3798, 3799, 3800, 3801, 3802, 3803, 3804, 3805, 3806, 3807, 3808, 3809, 3810, 3811, 3812, 3813, 3814, 3815, 3816, 3817, 3818, 3819, 3820, 3821, 3822, 3823, 3824, 3825, 3826, 3827, 3828, 3829, 3830, 3831, 3832, 3833, 3834, 3835, 3836, 3837, 3838, 3839, 3840, 3841, 3842, 3843, 3844, 3845, 3846, 3847, 3848, 3849, 3850, 3851, 3852, 3853, 3854, 3855, 3856, 3857, 3858, 3859, 3860, 3861, 3862, 3863, 3864, 3865, 3866, 3867, 3868, 3869, 3870, 3871, 3872, 3873, 3874, 3875, 3876, 3877, 3878, 3879, 3880, 3881, 3882, 3883, 3884, 3885, 3886, 3887, 3888, 3889, 3890, 3891, 3892, 3893, 3894, 3895, 3896, 3897, 3898, 3899, 3900, 3901, 3902, 3903, 3904, 3905, 3906, 3907, 3908, 3909, 3910, 3911, 3912, 3913, 3914, 3915, 3916, 3917, 3918, 3919, 3920, 3921, 3922, 3923, 3924, 3925, 3926, 3927, 3928, 3929, 3930, 3931, 3932, 3933, 3934, 3935, 3936, 3937, 3938, 3939, 3940, 3941, 3942, 3943, 3944, 3945, 3946, 3947, 3948, 3949, 3950, 3951, 3952, 3953, 3954, 3955, 3956, 3957, 3958, 3959, 3960, 3961, 3962, 3963, 3964, 3965, 3966, 3967, 3968, 3969, 3970, 3971, 3972, 3973, 3974, 3975, 3976, 3977, 3978, 3979, 3980, 3981, 3982, 3983, 3984, 3985, 3986, 3987, 3988, 3989, 3990, 3991, 3992, 3993, 3994, 3995, 3996, 3997, 3998, 3999, 4000, 4001, 4002, 4003, 4004, 4005, 4006, 4007, 4008, 4009, 4010, 4011, 4012, 4013, 4014, 4015, 4016, 4017, 4018, 4019, 4020, 4021, 4022, 4023, 4024, 4025, 4026, 4027, 4028, 4029, 4030, 4031, 4032, 4033, 4034, 4035, 4036, 4037, 4038, 4039, 4040, 4041, 4042, 4043, 4044, 4045, 4046, 4047, 4048, 4049, 4050, 4051, 4052, 4053, 4054, 4055, 4056, 4057, 4058, 4059, 4060, 4061, 4062, 4063, 4064, 4065, 4066, 4067, 4068, 4069, 4070, 4071, 4072, 4073, 4074, 4075, 4076, 4077, 4078, 4079, 4080, 4081, 4082, 4083, 4084, 4085, 4086, 4087, 4088, 4089, 4090, 4091, 4092, 4093, 4094, 4095, 4096, 4097, 4098, 4099, 4100, 4101, 4102, 4103, 4104, 4105, 4106, 4107, 4108, 4109, 4110, 4111, 4112, 4113, 4114, 4115, 4116, 4117, 4118, 4119, 4120, 4121, 4122, 4123, 4124, 4125, 4126, 4127, 4128, 4129, 4130, 4131, 4132, 4133, 4134, 4135, 4136, 4137, 4138, 4139, 4140, 4141, 4142, 4143, 4144, 4145, 4146, 4147, 4148, 4149, 4150, 4151, 4152, 4153, 4154, 4155, 4156, 4157, 4158, 4159, 4160, 4161, 4162, 4163, 4164, 4165, 4166, 4167, 4168, 4169, 4170, 4171, 4172, 4173, 4174, 4175, 4176, 4177, 4178, 4179, 4180, 4181, 4182, 4183, 4184, 4185, 4186, 4187, 4188, 4189, 4190, 4191, 4192, 4193, 4194, 4195, 4196, 4197, 4198, 4199, 4200, 4201, 4202, 4203, 4204, 4205, 4206, 4207, 4208, 4209, 4210, 4211, 4212, 4213, 4214, 4215, 4216, 4217, 4218, 4219, 4220, 4221, 4222, 4223, 4224, 4225, 4226, 4227, 4228, 4229, 4230, 4231, 4232, 4233, 4234, 4235, 4236, 4237, 4238, 4239, 4240, 4241, 4242, 4243, 4244, 4245, 4246, 4247, 4248, 4249, 4250, 4251, 4252, 4253, 4254, 4255, 4256, 4257, 4258, 4259, 4260, 4261, 4262, 4263, 4264, 4265, 4266, 4267, 4268, 4269, 4270, 4271, 4272, 4273, 4274, 4275, 4276, 4277, 4278, 4279, 4280, 4281, 4282, 4283, 4284, 4285, 4286, 4287, 4288, 4289, 4290, 4291, 4292, 4293, 4294, 4295, 4296, 4297, 4298, 4299, 4300, 4301, 4302, 4303, 4304, 4305, 4306, 4307, 4308, 4309, 4310, 4311, 4312, 4313, 4314, 4315, 4316, 4317, 4318, 4319, 4320, 4321, 4322, 4323, 4324, 4325, 4326, 4327, 4328, 4329, 4330, 4331, 4332, 4333, 4334, 4335, 4336, 4337, 4338, 4339, 4340, 4341, 4342, 4343, 4344, 4345, 4346, 4347, 4348, 4349, 4350, 4351, 4352, 4353, 4354, 4355, 4356, 4357, 4358, 4359,

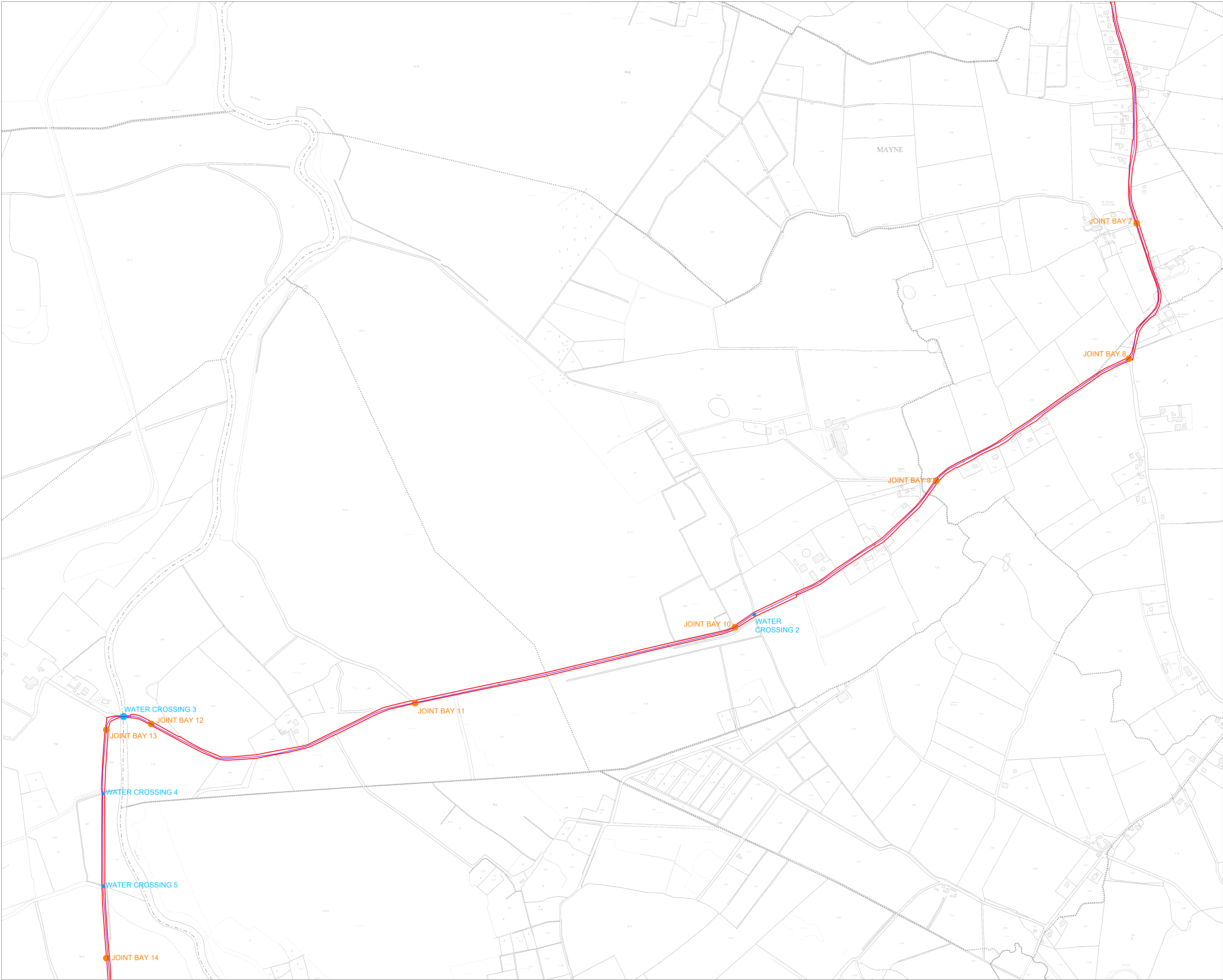

- Project Design Drawing Notes**
1. Drawings issued are for planning application purposes only.
 2. Drawings not to be used for construction/contract conditions.
 3. Copyright, all rights reserved. No part herewith may be copied or reproduced partially or wholly in any form whatsoever without the prior notice of the copyright owner McCarthy Keville O'Sullivan.
 4. Do not scale off this drawing. Figured metric dimensions only should be taken off this drawing.
 5. All contractors, whether main or sub-contractors, must visit the site and are responsible for taking and checking any and all dimensions and levels that relate to the works.
 6. The use of or reliance upon this drawing shall be deemed to be acceptance of these conditions of use unless otherwise agreed in writing, such written agreement to be sought from and issued by the copyright holder to the use or reliance upon this drawing.
 7. Layout plans show typical Turbine rotor diameter as per turbine drawing.
 8. Final levels may vary depending on local ground conditions.
 9. Exact location of cable/joint bay in the road corridor to be subject to ESB specifications and agreement with Westmeath County Council

- Drawing Legend**
- Planning Application Boundary
 - Grid Connection Route
 - Joint Bay
 - Watercrossing

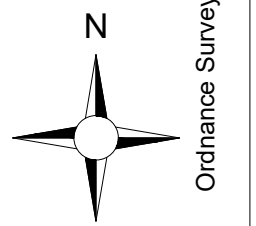

Ordnance Survey Ireland Licence No. CYAL50267517© Ordnance Survey Ireland/Government of Ireland

DRAWING TITLE: Site Location Plan Sheet 5 of 9	
PROJECT TITLE: Cooile Wind Farm FI, Co. Westmeath	
DRAWING BY: Joseph O'Brien	CHECKED BY: Meabhann Crowe
PROJECT No.: 200445g	DRAWING No.: 200445g - 08 FI
SCALE: 1:5,000 @ A1	DATE: 27.10.2022
OS SHEET No.: <small>004 005 006 007 008 009 010 011 012 013 014 015 016 017 018 019 020 021 022 023 024 025 026 027 028 029 030 031 032 033 034 035 036 037 038 039 040 041 042 043 044 045 046 047 048 049 050 051 052 053 054 055 056 057 058 059 060 061 062 063 064 065 066 067 068 069 070 071 072 073 074 075 076 077 078 079 080 081 082 083 084 085 086 087 088 089 090 091 092 093 094 095 096 097 098 099 100 101 102 103 104 105 106 107 108 109 110 111 112 113 114 115 116 117 118 119 120 121 122 123 124 125 126 127 128 129 130 131 132 133 134 135 136 137 138 139 140 141 142 143 144 145 146 147 148 149 150 151 152 153 154 155 156 157 158 159 160 161 162 163 164 165 166 167 168 169 170 171 172 173 174 175 176 177 178 179 180 181 182 183 184 185 186 187 188 189 190 191 192 193 194 195 196 197 198 199 200 201 202 203 204 205 206 207 208 209 210 211 212 213 214 215 216 217 218 219 220 221 222 223 224 225 226 227 228 229 230 231 232 233 234 235 236 237 238 239 240 241 242 243 244 245 246 247 248 249 250 251 252 253 254 255 256 257 258 259 260 261 262 263 264 265 266 267 268 269 270 271 272 273 274 275 276 277 278 279 280 281 282 283 284 285 286 287 288 289 290 291 292 293 294 295 296 297 298 299 300 301 302 303 304 305 306 307 308 309 310 311 312 313 314 315 316 317 318 319 320 321 322 323 324 325 326 327 328 329 330 331 332 333 334 335 336 337 338 339 340 341 342 343 344 345 346 347 348 349 350 351 352 353 354 355 356 357 358 359 360 361 362 363 364 365 366 367 368 369 370 371 372 373 374 375 376 377 378 379 380 381 382 383 384 385 386 387 388 389 390 391 392 393 394 395 396 397 398 399 400 401 402 403 404 405 406 407 408 409 410 411 412 413 414 415 416 417 418 419 420 421 422 423 424 425 426 427 428 429 430 431 432 433 434 435 436 437 438 439 440 441 442 443 444 445 446 447 448 449 450 451 452 453 454 455 456 457 458 459 460 461 462 463 464 465 466 467 468 469 470 471 472 473 474 475 476 477 478 479 480 481 482 483 484 485 486 487 488 489 490 491 492 493 494 495 496 497 498 499 500 501 502 503 504 505 506 507 508 509 510 511 512 513 514 515 516 517 518 519 520 521 522 523 524 525 526 527 528 529 530 531 532 533 534 535 536 537 538 539 540 541 542 543 544 545 546 547 548 549 550 551 552 553 554 555 556 557 558 559 560 561 562 563 564 565 566 567 568 569 570 571 572 573 574 575 576 577 578 579 580 581 582 583 584 585 586 587 588 589 590 591 592 593 594 595 596 597 598 599 600 601 602 603 604 605 606 607 608 609 610 611 612 613 614 615 616 617 618 619 620 621 622 623 624 625 626 627 628 629 630 631 632 633 634 635 636 637 638 639 640 641 642 643 644 645 646 647 648 649 650 651 652 653 654 655 656 657 658 659 660 661 662 663 664 665 666 667 668 669 670 671 672 673 674 675 676 677 678 679 680 681 682 683 684 685 686 687 688 689 690 691 692 693 694 695 696 697 698 699 700 701 702 703 704 705 706 707 708 709 710 711 712 713 714 715 716 717 718 719 720 721 722 723 724 725 726 727 728 729 730 731 732 733 734 735 736 737 738 739 740 741 742 743 744 745 746 747 748 749 750 751 752 753 754 755 756 757 758 759 760 761 762 763 764 765 766 767 768 769 770 771 772 773 774 775 776 777 778 779 780 781 782 783 784 785 786 787 788 789 790 791 792 793 794 795 796 797 798 799 800 801 802 803 804 805 806 807 808 809 810 811 812 813 814 815 816 817 818 819 820 821 822 823 824 825 826 827 828 829 830 831 832 833 834 835 836 837 838 839 840 841 842 843 844 845 846 847 848 849 850 851 852 853 854 855 856 857 858 859 860 861 862 863 864 865 866 867 868 869 870 871 872 873 874 875 876 877 878 879 880 881 882 883 884 885 886 887 888 889 890 891 892 893 894 895 896 897 898 899 900 901 902 903 904 905 906 907 908 909 910 911 912 913 914 915 916 917 918 919 920 921 922 923 924 925 926 927 928 929 930 931 932 933 934 935 936 937 938 939 940 941 942 943 944 945 946 947 948 949 950 951 952 953 954 955 956 957 958 959 960 961 962 963 964 965 966 967 968 969 970 971 972 973 974 975 976 977 978 979 980 981 982 983 984 985 986 987 988 989 990 991 992 993 994 995 996 997 998 999 1000</small>	

MKO
 Planning and
 Environmental
 Consultants
 Tuam Road, Galway
 Ireland: H91 VM84
 +353 (0) 91 735611
 email: info@www.mkofireland.ie
 Website: www.mkofireland.ie

Project Design Drawing Notes

1. Drawings issued are for planning application purposes only.
2. Drawings not to be used for construction/contract conditions.
3. Copyright, all rights reserved. No part hereof may be copied or reproduced partially or wholly in any form whatsoever without the prior notice of the copyright owner McCarthy Keville O'Sullivan.
4. Do not scale off this drawing. Figured metric dimensions only should be taken off this drawing.
5. All contractors, whether main or sub-contractors, must visit the site and are responsible for taking and checking any and all dimensions and levels that relate to the works.
6. The use of or reliance upon this drawing shall be deemed to be acceptance of these conditions of use unless otherwise agreed in writing, such written agreement to be sought from and issued by the copyright holder to the use or reliance upon this drawing.
7. Layout plans show typical Turbine rotor diameter as per turbine drawing.
8. Final levels may vary depending on local ground conditions.
9. Exact location of cable/joint bay in the road corridor to be subject to ESB specifications and agreement with Westmeath County Council



Drawing Legend

- Planning Application Boundary
- Grid Connection Route
- Joint Bay
- Watercrossing

Ordnance Survey Ireland Licence No. CYAL50267517 © Ordnance Survey Ireland/Government of Ireland

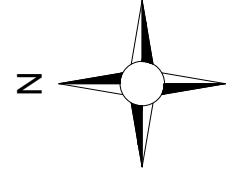

**Site Location Plan
Sheet 6 of 9**

PROJECT TITLE: Coole Wind Farm FI, Co. Westmeath	
DRAWING BY: Joseph O'Brien	CHECKED BY: Meabhann Crowe
PROJECT No: 200445g	DRAWING No: 200445g - 09 FI
SCALE: 1:5,000 @ A1	DATE: 27.10.2022

OS SHEET No.: 2004 2005 2006 2007 2008 2009 2010 2011 2012 2013 2014 2015 2016 2017 2018 2019 2020 2021 2022 2023 2024 2025 2026 2027 2028 2029 2030 2031 2032 2033 2034 2035 2036 2037 2038 2039 2040 2041 2042 2043 2044 2045 2046



MKO
Planning and
Environmental
Consultants
Tuum Road, Galway
Ireland, H91 VW84
+353 (0) 91 735611
email: info@www.mkofireland.ie
Website: www.mkofireland.ie

Project Design Drawing Notes
1. Drawings issued are for planning application purposes only.
2. Drawings not to be used for construction/contract conditions.
3. Copyright, all rights reserved. No part hereof may be copied or reproduced partially or wholly in any form whatsoever without the prior notice of the copyright owner McCarthy Keville O'Sullivan.
4. Do not scale off this drawing. Figured metric dimensions only should be taken off this drawing.
5. All contractors, whether main or sub-contractors, must visit the site and are responsible for taking and checking any and all dimensions and levels that relate to the works.
6. The use of or reliance upon this drawing shall be deemed to be acceptance of these conditions of use unless otherwise agreed in writing, such written agreement to be sought from and issued by the copyright holder to the use or reliance upon this drawing.
7. Layout plans show typical Turbine rotor diameter as per turbine drawing.
8. Final levels may vary depending on local ground conditions.
9. Exact location of cable/joint bay in the road corridor to be subject to ESB specifications and agreement with Westmeath County Council

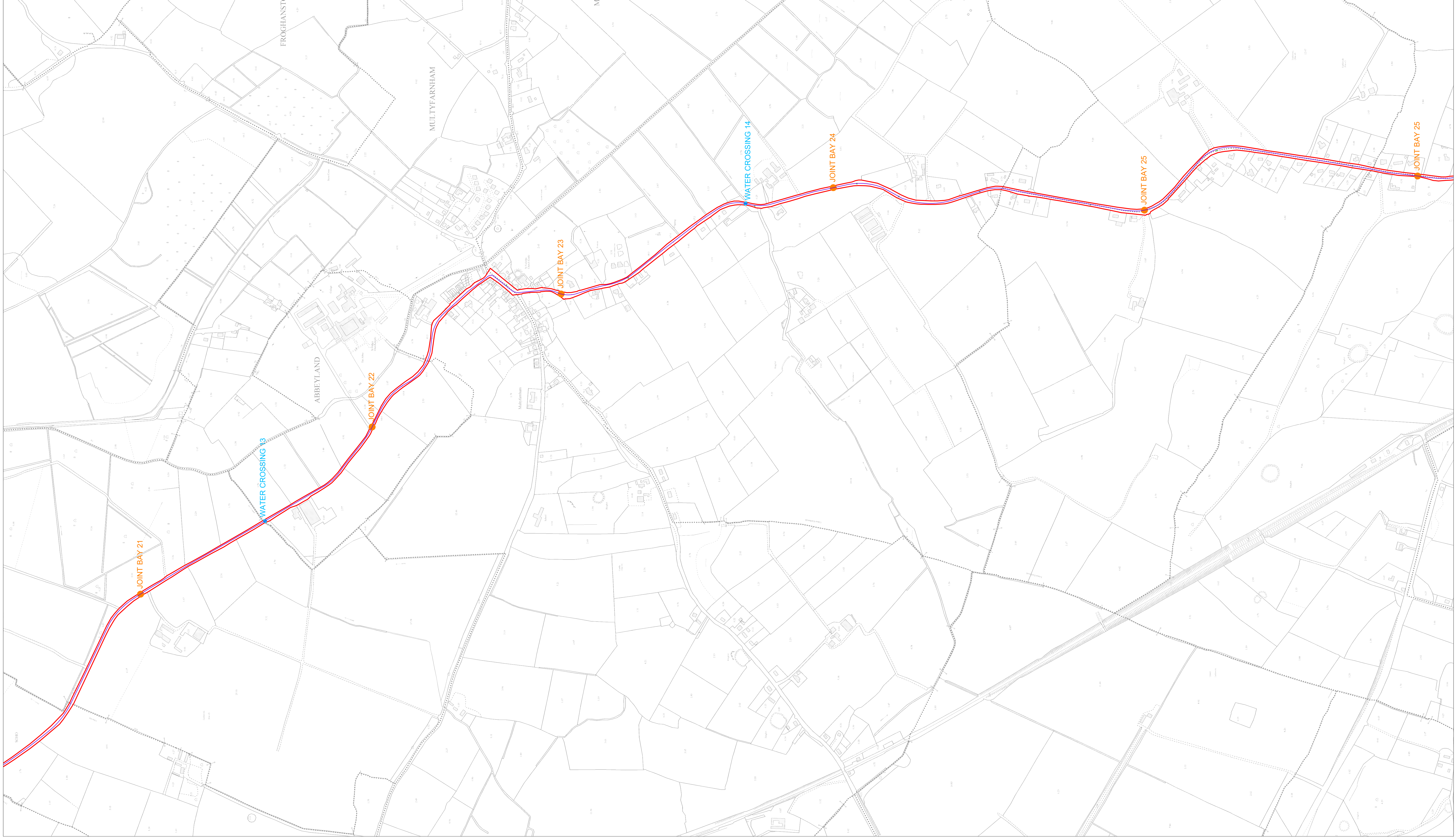

Drawing Legend

- Planning Application Boundary
- Grid Connection Route
- Joint Bay
- Watercrossing

Ordnance Survey Ireland Licence No. CYAL50267517 © Ordnance Survey Ireland/Government of Ireland

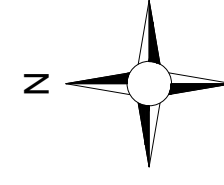

DRAWING TITLE
**Site Location Plan
Sheet 7 of 9**

PROJECT TITLE

Cooile Wind Farm FI, Co. Westmeath
DRAWING BY: **Joseph O'Brien**
CHECKED BY: **Meabhann Crowe**
PROJECT No: **200445g**
DRAWING No: **200445g - 10 FI**
SCALE: **1:5,000 @ A1**
DATE: **27.10.2022**

OS SHEET No.: 2500, 2502, 2504, 2506, 2508, 2510, 2512, 2514, 2516, 2518, 2520, 2522, 2524, 2526, 2528, 2530, 2532, 2534, 2536, 2538, 2540, 2542, 2544, 2546, 2548, 2550, 2552, 2554, 2556, 2558, 2560, 2562, 2564, 2566, 2568, 2570, 2572, 2574, 2576, 2578, 2580, 2582, 2584, 2586, 2588, 2590, 2592, 2594, 2596, 2598, 2600, 2602, 2604, 2606, 2608, 2610, 2612, 2614, 2616, 2618, 2620, 2622, 2624, 2626, 2628, 2630, 2632, 2634, 2636, 2638, 2640, 2642, 2644, 2646, 2648, 2650, 2652, 2654, 2656, 2658, 2660, 2662, 2664, 2666, 2668, 2670, 2672, 2674, 2676, 2678, 2680, 2682, 2684, 2686, 2688, 2690, 2692, 2694, 2696, 2698, 2700, 2702, 2704, 2706, 2708, 2710, 2712, 2714, 2716, 2718, 2720, 2722, 2724, 2726, 2728, 2730, 2732, 2734, 2736, 2738, 2740, 2742, 2744, 2746, 2748, 2750, 2752, 2754, 2756, 2758, 2760, 2762, 2764, 2766, 2768, 2770, 2772, 2774, 2776, 2778, 2780, 2782, 2784, 2786, 2788, 2790, 2792, 2794, 2796, 2798, 2800, 2802, 2804, 2806, 2808, 2810, 2812, 2814, 2816, 2818, 2820, 2822, 2824, 2826, 2828, 2830, 2832, 2834, 2836, 2838, 2840, 2842, 2844, 2846, 2848, 2850, 2852, 2854, 2856, 2858, 2860, 2862, 2864, 2866, 2868, 2870, 2872, 2874, 2876, 2878, 2880, 2882, 2884, 2886, 2888, 2890, 2892, 2894, 2896, 2898, 2900, 2902, 2904, 2906, 2908, 2910, 2912, 2914, 2916, 2918, 2920, 2922, 2924, 2926, 2928, 2930, 2932, 2934, 2936, 2938, 2940, 2942, 2944, 2946, 2948, 2950, 2952, 2954, 2956, 2958, 2960, 2962, 2964, 2966, 2968, 2970, 2972, 2974, 2976, 2978, 2980, 2982, 2984, 2986, 2988, 2990, 2992, 2994, 2996, 2998, 3000



MKO
Planning and
Environmental
Consultants
Tean Road, Galway
Ireland, H91 VW84
+353 (0) 91 735611
email: info@www.mkoireland.ie
Website: www.mkoireland.ie

Project Design Drawing Notes

1. Drawings issued are for planning application purposes only.
2. Drawings not to be used for construction/contract conditions.
3. Copyright, all rights reserved. No part hereof may be copied or reproduced partially or wholly in any form whatsoever without the prior notice of the copyright owner McCarthy Keville O'Sullivan.
4. Do not scale off this drawing. Figured metric dimensions only should be taken off this drawing.
5. All contractors, whether main or sub-contractors, must visit the site and are responsible for taking and checking any and all dimensions and levels that relate to the works.
6. The use of or reliance upon this drawing shall be deemed to be acceptance of these conditions of use unless otherwise agreed in writing, such written agreement to be sought from and issued by the copyright holder to the use or reliance upon this drawing.
7. Layout plans show typical Turbine rotor diameter as per turbine drawing.
8. Final levels may vary depending on local ground conditions.
9. Exact location of cable/joint bay in the road corridor to be subject to ESB specifications and agreement with Westmeath County Council



Drawing Legend

- Planning Application Boundary (Red X)
- Site Notice (Red line)
- Grid Connection Route (Purple line)
- Proposed Cable Alteration (Orange line)
- Joint Bay (Orange dot)
- Watercrossing (Blue dot)
- Existing Mullingar Substation (Green rectangle)

Ordnance Survey Ireland Licence No. CYAL50267517 © Ordnance Survey Ireland/Government of Ireland

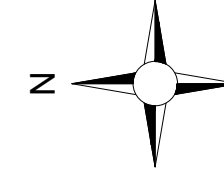

**Site Location Plan
Sheet 9 of 9**

PROJECT TITLE: Coolle Wind Farm FI, Co. Westmeath	
DRAWING BY: Joseph O'Brien	CHECKED BY: Meabhann Crowe
PROJECT No: 200445g	DRAWING No: 200445g - 12 FI
SCALE: 1:5,000 @ A1	DATE: 27.10.2022
OS SHEET No.: 2504, 2505, 2506, 2507, 2508, 2509, 2510, 2511, 2512, 2513, 2514, 2515, 2516, 2517, 2518, 2519, 2520, 2521, 2522, 2523, 2524, 2525, 2526, 2527, 2528, 2529, 2530, 2531, 2532, 2533, 2534, 2535, 2536, 2537, 2538, 2539, 2540, 2541, 2542, 2543, 2544, 2545, 2546, 2547, 2548, 2549, 2550, 2551, 2552, 2553, 2554, 2555, 2556, 2557, 2558, 2559, 2560, 2561, 2562, 2563, 2564, 2565, 2566, 2567, 2568, 2569, 2570, 2571, 2572, 2573, 2574, 2575, 2576, 2577, 2578, 2579, 2580, 2581, 2582, 2583, 2584, 2585, 2586, 2587, 2588, 2589, 2590, 2591, 2592, 2593, 2594, 2595, 2596, 2597, 2598, 2599, 2600, 2601, 2602, 2603, 2604, 2605, 2606, 2607, 2608, 2609, 2610, 2611, 2612, 2613, 2614, 2615, 2616, 2617, 2618, 2619, 2620, 2621, 2622, 2623, 2624, 2625, 2626, 2627, 2628, 2629, 2630, 2631, 2632, 2633, 2634, 2635, 2636, 2637, 2638, 2639, 2640, 2641, 2642, 2643, 2644, 2645, 2646, 2647, 2648, 2649, 2650, 2651, 2652, 2653, 2654, 2655, 2656, 2657, 2658, 2659, 2660, 2661, 2662, 2663, 2664, 2665, 2666, 2667, 2668, 2669, 2670, 2671, 2672, 2673, 2674, 2675, 2676, 2677, 2678, 2679, 2680, 2681, 2682, 2683, 2684, 2685, 2686, 2687, 2688, 2689, 2690, 2691, 2692, 2693, 2694, 2695, 2696, 2697, 2698, 2699, 2700, 2701, 2702, 2703, 2704, 2705, 2706, 2707, 2708, 2709, 2710, 2711, 2712, 2713, 2714, 2715, 2716, 2717, 2718, 2719, 2720, 2721, 2722, 2723, 2724, 2725, 2726, 2727, 2728, 2729, 2730, 2731, 2732, 2733, 2734, 2735, 2736, 2737, 2738, 2739, 2740, 2741, 2742, 2743, 2744, 2745, 2746, 2747, 2748, 2749, 2750, 2751, 2752, 2753, 2754, 2755, 2756, 2757, 2758, 2759, 2760, 2761, 2762, 2763, 2764, 2765, 2766, 2767, 2768, 2769, 2770, 2771, 2772, 2773, 2774, 2775, 2776, 2777, 2778, 2779, 2780, 2781, 2782, 2783, 2784, 2785, 2786, 2787, 2788, 2789, 2790, 2791, 2792, 2793, 2794, 2795, 2796, 2797, 2798, 2799, 2800, 2801, 2802, 2803, 2804, 2805, 2806, 2807, 2808, 2809, 2810, 2811, 2812, 2813, 2814, 2815, 2816, 2817, 2818, 2819, 2820, 2821, 2822, 2823, 2824, 2825, 2826, 2827, 2828, 2829, 2830, 2831, 2832, 2833, 2834, 2835, 2836, 2837, 2838, 2839, 2840, 2841, 2842, 2843, 2844, 2845, 2846, 2847, 2848, 2849, 2850, 2851, 2852, 2853, 2854, 2855, 2856, 2857, 2858, 2859, 2860, 2861, 2862, 2863, 2864, 2865, 2866, 2867, 2868, 2869, 2870, 2871, 2872, 2873, 2874, 2875, 2876, 2877, 2878, 2879, 2880, 2881, 2882, 2883, 2884, 2885, 2886, 2887, 2888, 2889, 2890, 2891, 2892, 2893, 2894, 2895, 2896, 2897, 2898, 2899, 2900, 2901, 2902, 2903, 2904, 2905, 2906, 2907, 2908, 2909, 2910, 2911, 2912, 2913, 2914, 2915, 2916, 2917, 2918, 2919, 2920, 2921, 2922, 2923, 2924, 2925, 2926, 2927, 2928, 2929, 2930, 2931, 2932, 2933, 2934, 2935, 2936, 2937, 2938, 2939, 2940, 2941, 2942, 2943, 2944, 2945, 2946, 2947, 2948, 2949, 2950, 2951, 2952, 2953, 2954, 2955, 2956, 2957, 2958, 2959, 2960, 2961, 2962, 2963, 2964, 2965, 2966, 2967, 2968, 2969, 2970, 2971, 2972, 2973, 2974, 2975, 2976, 2977, 2978, 2979, 2980, 2981, 2982, 2983, 2984, 2985, 2986, 2987, 2988, 2989, 2990, 2991, 2992, 2993, 2994, 2995, 2996, 2997, 2998, 2999, 3000, 3001, 3002, 3003, 3004, 3005, 3006, 3007, 3008, 3009, 3010, 3011, 3012, 3013, 3014, 3015, 3016, 3017, 3018, 3019, 3020, 3021, 3022, 3023, 3024, 3025, 3026, 3027, 3028, 3029, 3030, 3031, 3032, 3033, 3034, 3035, 3036, 3037, 3038, 3039, 3040, 3041, 3042, 3043, 3044, 3045, 3046, 3047, 3048, 3049, 3050, 3051, 3052, 3053, 3054, 3055, 3056, 3057, 3058, 3059, 3060, 3061, 3062, 3063, 3064, 3065, 3066, 3067, 3068, 3069, 3070, 3071, 3072, 3073, 3074, 3075, 3076, 3077, 3078, 3079, 3080, 3081, 3082, 3083, 3084, 3085, 3086, 3087, 3088, 3089, 3090, 3091, 3092, 3093, 3094, 3095, 3096, 3097, 3098, 3099, 3100, 3101, 3102, 3103, 3104, 3105, 3106, 3107, 3108, 3109, 3110, 3111, 3112, 3113, 3114, 3115, 3116, 3117, 3118, 3119, 3120, 3121, 3122, 3123, 3124, 3125, 3126, 3127, 3128, 3129, 3130, 3131, 3132, 3133, 3134, 3135, 3136, 3137, 3138, 3139, 3140, 3141, 3142, 3143, 3144, 3145, 3146, 3147, 3148, 3149, 3150, 3151, 3152, 3153, 3154, 3155, 3156, 3157, 3158, 3159, 3160, 3161, 3162, 3163, 3164, 3165, 3166, 3167, 3168, 3169, 3170, 3171, 3172, 3173, 3174, 3175, 3176, 3177, 3178, 3179, 3180, 3181, 3182, 3183, 3184, 3185, 3186, 3187, 3188, 3189, 3190, 3191, 3192, 3193, 3194, 3195, 3196, 3197, 3198, 3199, 3200, 3201, 3202, 3203, 3204, 3205, 3206, 3207, 3208, 3209, 3210, 3211, 3212, 3213, 3214, 3215, 3216, 3217, 3218, 3219, 3220, 3221, 3222, 3223, 3224, 3225, 3226, 3227, 3228, 3229, 3230, 3231, 3232, 3233, 3234, 3235, 3236, 3237, 3238, 3239, 3240, 3241, 3242, 3243, 3244, 3245, 3246, 3247, 3248, 3249, 3250, 3251, 3252, 3253, 3254, 3255, 3256, 3257, 3258, 3259, 3260, 3261, 3262, 3263, 3264, 3265, 3266, 3267, 3268, 3269, 3270, 3271, 3272, 3273, 3274, 3275, 3276, 3277, 3278, 3279, 3280, 3281, 3282, 3283, 3284, 3285, 3286, 3287, 3288, 3289, 3290, 3291, 3292, 3293, 3294, 3295, 3296, 3297, 3298, 3299, 3300, 3301, 3302, 3303, 3304, 3305, 3306, 3307, 3308, 3309, 3310, 3311, 3312, 3313, 3314, 3315, 3316, 3317, 3318, 3319, 3320, 3321, 3322, 3323, 3324, 3325, 3326, 3327, 3328, 3329, 3330, 3331, 3332, 3333, 3334, 3335, 3336, 3337, 3338, 3339, 3340, 3341, 3342, 3343, 3344, 3345, 3346, 3347, 3348, 3349, 3350, 3351, 3352, 3353, 3354, 3355, 3356, 3357, 3358, 3359, 3360, 3361, 3362, 3363, 3364, 3365, 3366, 3367, 3368, 3369, 3370, 3371, 3372, 3373, 3374, 3375, 3376, 3377, 3378, 3379, 3380, 3381, 3382, 3383, 3384, 3385, 3386, 3387, 3388, 3389, 3390, 3391, 3392, 3393, 3394, 3395, 3396, 3397, 3398, 3399, 3400, 3401, 3402, 3403, 3404, 3405, 3406, 3407, 3408, 3409, 3410, 3411, 3412, 3413, 3414, 3415, 3416, 3417, 3418, 3419, 3420, 3421, 3422, 3423, 3424, 3425, 3426, 3427, 3428, 3429, 3430, 3431, 3432, 3433, 3434, 3435, 3436, 3437, 3438, 3439, 3440, 3441, 3442, 3443, 3444, 3445, 3446, 3447, 3448, 3449, 3450, 3451, 3452, 3453, 3454, 3455, 3456, 3457, 3458, 3459, 3460, 3461, 3462, 3463, 3464, 3465, 3466, 3467, 3468, 3469, 3470, 3471, 3472, 3473, 3474, 3475, 3476, 3477, 3478, 3479, 3480, 3481, 3482, 3483, 3484, 3485, 3486, 3487, 3488, 3489, 3490, 3491, 3492, 3493, 3494, 3495, 3496, 3497, 3498, 3499, 3500, 3501, 3502, 3503, 3504, 3505, 3506, 3507, 3508, 3509, 3510, 3511, 3512, 3513, 3514, 3515, 3516, 3517, 3518, 3519, 3520, 3521, 3522, 3523, 3524, 3525, 3526, 3527, 3528, 3529, 3530, 3531, 3532, 3533, 3534, 3535, 3536, 3537, 3538, 3539, 3540, 3541, 3542, 3543, 3544, 3545, 3546, 3547, 3548, 3549, 3550, 3551, 3552, 3553, 3554, 3555, 3556, 3557, 3558, 3559, 3560, 3561, 3562, 3563, 3564, 3565, 3566, 3567, 3568, 3569, 3570, 3571, 3572, 3573, 3574, 3575, 3576, 3577, 3578, 3579, 3580, 3581, 3582, 3583, 3584, 3585, 3586, 3587, 3588, 3589, 3590, 3591, 3592, 3593, 3594, 3595, 3596, 3597, 3598, 3599, 3600, 3601, 3602, 3603, 3604, 3605, 3606, 3607, 3608, 3609, 3610, 3611, 3612, 3613, 3614, 3615, 3616, 3617, 3618, 3619, 3620, 3621, 3622, 3623, 3624, 3625, 3626, 3627, 3628, 3629, 3630, 3631, 3632, 3633, 3634, 3635, 3636, 3637, 3638, 3639, 3640, 3641, 3642, 3643, 3644, 3645, 3646, 3647, 3648, 3649, 3650, 3651, 3652, 3653, 3654, 3655, 3656, 3657, 3658, 3659, 3660, 3661, 3662, 3663, 3664, 3665, 3666, 3667, 3668, 3669, 3670, 3671, 3672, 3673, 3674, 3675, 3676, 3677, 3678, 3679, 3680, 3681, 3682, 3683, 3684, 3685, 3686, 3687, 3688, 3689, 3690, 3691, 3692, 3693, 3694, 3695, 3696, 3697, 3698, 3699, 3700, 3701, 3702, 3703, 3704, 3705, 3706, 3707, 3708, 3709, 3710, 3711, 3712, 3713, 3714, 3715, 3716, 3717, 3718, 3719, 3720, 3721, 3722, 3723, 3724, 3725, 3726, 3727, 3728, 3729, 3730, 3731, 3732, 3733, 3734, 3735, 3736, 3737, 3738, 3739, 3740, 3741, 3742, 3743, 3744, 3745, 3746, 3747, 3748, 3749, 3750, 3751, 3752, 3753, 3754, 3755, 3756, 3757, 3758, 3759, 3760, 3761, 3762, 3763, 3764, 3765, 3766, 3767, 3768, 3769, 3770, 3771, 3772, 3773, 3774, 3775, 3776, 3777, 3778, 3779, 3780, 3781, 3782, 3783, 3784, 3785, 3786, 3787, 3788, 3789, 3790, 3791, 3792, 3793, 3794, 3795, 3796, 3797, 3798, 3799, 3800, 3801, 3802, 3803, 3804, 3805, 3806, 3807, 3808, 3809, 3810, 3811, 3812, 3813, 3814, 3815, 3816, 3817, 3818, 3819, 3820, 3821, 3822, 3823, 3824, 3825, 3826, 3827, 3828, 3829, 3830, 3831, 3832, 3833, 3834, 3835, 3836, 3837, 3838, 3839, 3840, 3841, 3842, 3843, 3844, 3845, 3846, 3847, 3848, 3849, 3850, 3851, 3852, 3853, 3854, 3855, 3856, 3857, 3858, 3859, 3860, 3861, 3862, 3863, 3864, 3865, 3866, 3867, 3868, 3869, 3870, 3871, 3872, 3873, 3874, 3875, 3876, 3877, 3878, 3879, 3880, 3881, 3882, 3883, 3884, 3885, 3886, 3887, 3888, 3889, 3890, 3891, 3892, 3893, 3894, 3895, 3896, 3897, 3898, 3899, 3900, 3901, 3902, 3903, 3904, 3905, 3906, 3907, 3908, 3909, 3910, 3911, 3912, 3913, 3914, 3915, 3916, 3917, 3918, 3919, 3920, 3921, 3922, 3923, 3924, 3925, 3926, 3927, 3928, 3929, 3930, 3931, 3932, 3933, 3934, 3935, 3936, 3937, 3938, 3939, 3940, 3941, 3942, 3943, 3944, 3945, 3946, 3947, 3948, 3949, 3950, 3951, 3952, 3953, 3954, 3955, 3956, 3957, 3958, 3959, 3960, 3961, 3962, 3963, 3964, 3965, 3966, 3967, 3968, 3969, 3970, 3971, 3972, 3973, 3974, 3975, 3976, 3977, 3978, 3979, 3980, 3981, 3982, 3983, 3984, 3985, 3986, 3987, 3988, 3989, 3990, 3991, 3992, 3993, 3994, 3995, 3996, 3997, 3998, 3999, 4000, 4001, 4002, 4003, 4004, 4005, 4006, 4007, 4008, 4009, 4010, 4011, 4012, 4013, 4014, 4015, 4016, 4017, 4018, 4019, 4020, 4021, 4022, 4023, 4024, 4025, 4026, 4027, 4028, 4029, 4030, 4031, 4032, 4033, 4034, 4035, 4036, 4037, 4038, 4039, 4040, 4041, 4042, 4043, 4044, 4045, 4046, 4047, 4048, 4049, 4050, 4051, 4052, 4053, 4054, 4055, 4056, 4057, 4058, 4059, 4060, 4061, 4062, 4063, 4064, 4065, 4066, 4067, 4068, 4069, 4070, 4071, 4072, 4073, 4074, 4075, 4076, 4077, 4078, 4079, 4080, 4081, 4082, 4083, 4084, 4085, 4086, 4087, 4088, 4089, 4090, 4091, 4092, 4093, 4094, 4095, 4096, 4097, 4098, 4099, 4100, 4101, 4102, 4103, 4104, 4105, 4106, 4107, 4108, 4109, 4110, 4111, 4112, 4113, 4114, 4115, 4116, 4117, 4118, 4119, 4120, 4121, 4122, 4123, 4124, 4125, 4126, 4127, 4128, 4129, 4130, 4131, 4132, 4133, 4134, 4135, 4136, 4137, 4138, 4139, 4140, 4141, 4142, 4143, 4144, 4145, 4146, 4147, 4148, 4149, 4150, 4151, 4152, 4153, 4154, 4155, 4156, 4157, 4158, 4159, 4160, 4161, 4162, 4163, 4164, 4165, 4166, 4167, 4168, 4169, 4170, 4171, 4172, 4173, 4174, 4175, 4176, 4177, 4178, 4179, 4180, 4181, 4182, 4183, 4184, 4185, 4186, 4187, 4188, 4189, 4190, 4191, 4192, 4193, 4194, 4195, 4196, 4197, 4198, 4199, 4200, 4201, 4202, 4203, 4204, 4205, 4206, 4207, 4208, 4209, 4210, 4211, 4212, 4213, 4214, 4215, 4216, 4217, 4218, 4219, 4220, 4221, 4222, 4223, 4224, 4225, 4226, 4227, 4228, 4229, 4230, 4231, 4232, 4233, 4234, 4235, 4236, 4237, 4238, 4239, 4240, 4241, 4242, 4243, 4244, 4245, 4246, 4247, 4248, 4249, 4250, 4251, 4252, 4253, 4254, 4255, 4256, 4257, 4258, 4259, 4260, 4261, 4262, 4263, 4264, 4265, 4266, 4267, 4268, 4269, 4270, 4271, 4272, 4273, 4274, 4275, 4276, 4277, 4278, 4279, 4280, 4281, 4282, 4283, 4284, 4285, 4286, 4287, 4288, 4289, 4290, 4291, 4292, 4293, 4294, 4295, 4296, 4297, 4298, 4299, 4300, 4301, 4302, 4303, 4304, 4305, 4306, 4307, 4308, 4309, 4310, 4311, 4312, 4313, 4314, 4315, 4316, 4317, 4318, 4319, 4320, 4321, 4322, 4323, 4324, 4325, 4326, 4327, 4328, 4329, 4330, 4331, 4332, 4333, 4334, 4335, 4336, 4337, 4338, 4339, 4340, 4341, 4342, 4343, 4344, 4345, 4346, 4347, 4348, 4349, 4350, 4351, 4352, 4353, 4354, 4355, 4356, 4357, 4358, 4359, 4360, 4361, 4362, 4363, 4364, 4365, 4366, 4367, 4368, 4369, 4370, 4371, 4372, 4373, 4374, 4375, 4376, 4377, 4378, 4379, 4380, 4381, 4382, 4383, 4384, 4385, 4	

Project Design Drawing Notes

1. Drawings issued are for planning application purposes only.
2. Drawings not to be used for construction/contract conditions.
3. Copyright, all rights reserved. No part hereof may be copied or reproduced partially or wholly in any form whatsoever without the prior notice of the copyright owner McCarthy Keville O'Sullivan.
4. Do not scale off this drawing. Figured metric dimensions only should be taken off this drawing.
5. All contractors, whether main or sub-contractors, must visit the site and are responsible for taking and checking any and all dimensions and levels that relate to the works.
6. The use of or reliance upon this drawing shall be deemed to be acceptance of these conditions of use unless otherwise agreed in writing, such written agreement to be sought from and issued by the copyright holder to the use or reliance upon this drawing.
7. Layout plans show typical Turbine rotor diameter as per turbine drawing.
8. Final levels may vary depending on local ground conditions.
9. Exact location of cable/joint bay in the road corridor to be subject to ESB specifications and agreement with Westmeath County Council

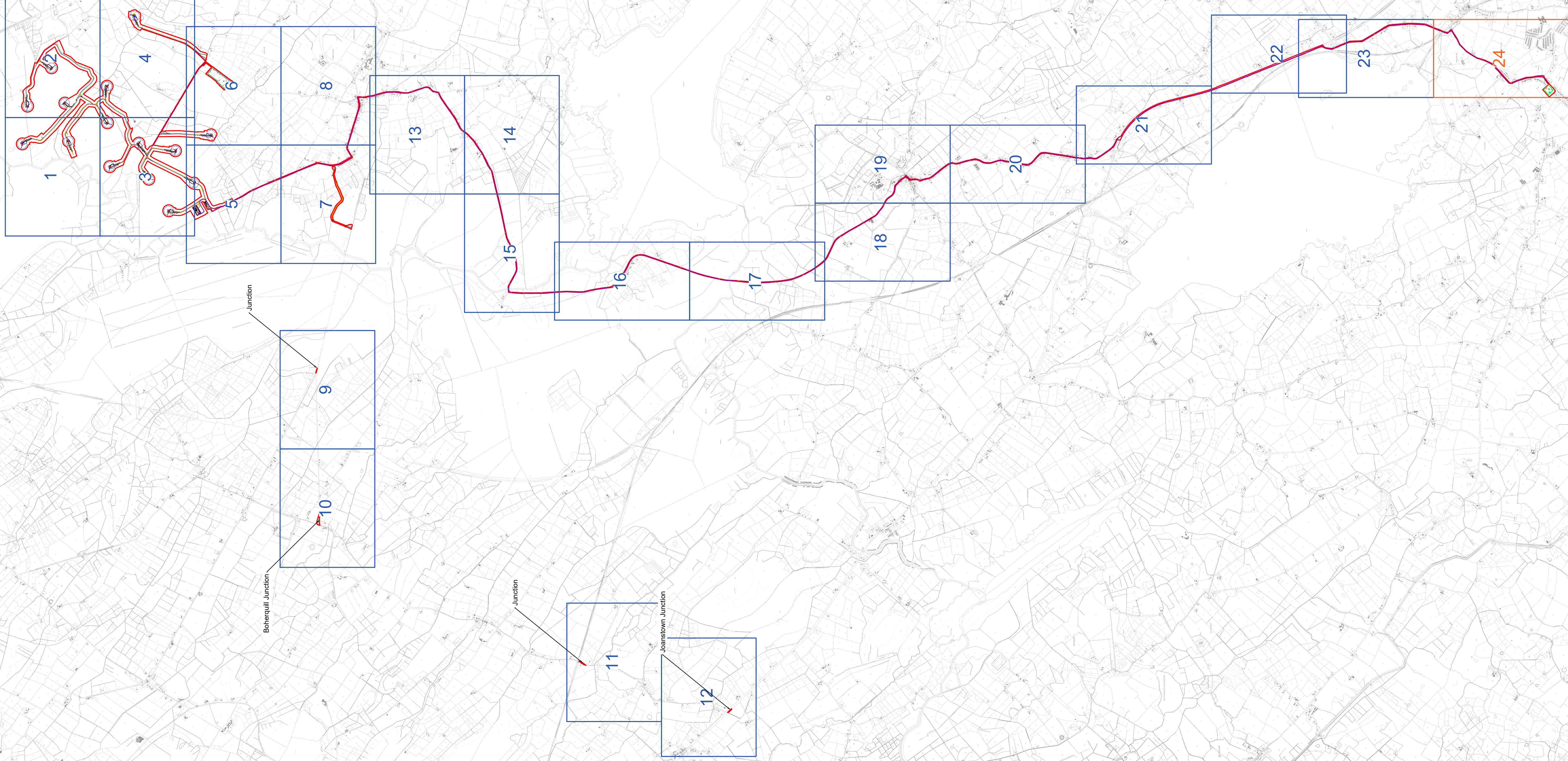

Drawing Legend

- Planning Application Boundary
- Existing Internal Road to be Upgraded
- Existing External Road to be Upgraded
- Proposed Road
- Crane Pad Hardstanding Area
- Turbine Foundation
- Turbine Sweep Area
- Borrow Pit
- Temporary Construction Compound
- Internal Electrical Cabling
- Grid Connection Route
- Proposed Cable Alteration
- Wind Farm Substation
- Existing Mullingar Substation

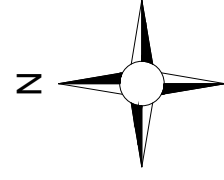

DRAWING TITLE

Site Location Key Plan B

PROJECT TITLE	Coolo Wind Farm FI, Co. Westmeath		
DRAWING BY	Joseph O'Brien	CHECKED BY	Meabhann Crowe
PROJECT NO.	200445g	DRAWING NO.	200445g - 13 FI
SCALE	1:30,000 @ A1	DATE	27.10.2022
OS SHEET No.	2564, 2565, 2566, 2567, 2568, 2569, 2570, 2571, 2572, 2573, 2574, 2575, 2576, 2577, 2578, 2579, 2580, 2581, 2582, 2583, 2584, 2585, 2586, 2587, 2588, 2589, 2590, 2591, 2592, 2593, 2594, 2595, 2596, 2597, 2598, 2599, 2600, 2601, 2602, 2603, 2604, 2605, 2606, 2607, 2608, 2609, 2610, 2611, 2612, 2613, 2614, 2615, 2616, 2617, 2618, 2619, 2620, 2621, 2622, 2623, 2624, 2625, 2626, 2627, 2628, 2629, 2630, 2631, 2632, 2633, 2634, 2635, 2636, 2637, 2638, 2639, 2640, 2641, 2642, 2643, 2644, 2645, 2646, 2647, 2648, 2649, 2650, 2651, 2652, 2653, 2654, 2655, 2656, 2657, 2658, 2659, 2660, 2661, 2662, 2663, 2664, 2665, 2666, 2667, 2668, 2669, 2670, 2671, 2672, 2673, 2674, 2675, 2676, 2677, 2678, 2679, 2680, 2681, 2682, 2683, 2684, 2685, 2686, 2687, 2688, 2689, 2690, 2691, 2692, 2693, 2694, 2695, 2696, 2697, 2698, 2699, 2700, 2701, 2702, 2703, 2704, 2705, 2706, 2707, 2708, 2709, 2710, 2711, 2712, 2713, 2714, 2715, 2716, 2717, 2718, 2719, 2720, 2721, 2722, 2723, 2724, 2725, 2726, 2727, 2728, 2729, 2730, 2731, 2732, 2733, 2734, 2735, 2736, 2737, 2738, 2739, 2740, 2741, 2742, 2743, 2744, 2745, 2746, 2747, 2748, 2749, 2750, 2751, 2752, 2753, 2754, 2755, 2756, 2757, 2758, 2759, 2760, 2761, 2762, 2763, 2764, 2765, 2766, 2767, 2768, 2769, 2770, 2771, 2772, 2773, 2774, 2775, 2776, 2777, 2778, 2779, 2780, 2781, 2782, 2783, 2784, 2785, 2786, 2787, 2788, 2789, 2790, 2791, 2792, 2793, 2794, 2795, 2796, 2797, 2798, 2799, 2800, 2801, 2802, 2803, 2804, 2805, 2806, 2807, 2808, 2809, 2810, 2811, 2812, 2813, 2814, 2815, 2816, 2817, 2818, 2819, 2820, 2821, 2822, 2823, 2824, 2825, 2826, 2827, 2828, 2829, 2830, 2831, 2832, 2833, 2834, 2835, 2836, 2837, 2838, 2839, 2840, 2841, 2842, 2843, 2844, 2845, 2846, 2847, 2848, 2849, 2850, 2851, 2852, 2853, 2854, 2855, 2856, 2857, 2858, 2859, 2860, 2861, 2862, 2863, 2864, 2865, 2866, 2867, 2868, 2869, 2870, 2871, 2872, 2873, 2874, 2875, 2876, 2877, 2878, 2879, 2880, 2881, 2882, 2883, 2884, 2885, 2886, 2887, 2888, 2889, 2890, 2891, 2892, 2893, 2894, 2895, 2896, 2897, 2898, 2899, 2900, 2901, 2902, 2903, 2904, 2905, 2906, 2907, 2908, 2909, 2910, 2911, 2912, 2913, 2914, 2915, 2916, 2917, 2918, 2919, 2920, 2921, 2922, 2923, 2924, 2925, 2926, 2927, 2928, 2929, 2930, 2931, 2932, 2933, 2934, 2935, 2936, 2937, 2938, 2939, 2940, 2941, 2942, 2943, 2944, 2945, 2946, 2947, 2948, 2949, 2950, 2951, 2952, 2953, 2954, 2955, 2956, 2957, 2958, 2959, 2960, 2961, 2962, 2963, 2964, 2965, 2966, 2967, 2968, 2969, 2970, 2971, 2972, 2973, 2974, 2975, 2976, 2977, 2978, 2979, 2980, 2981, 2982, 2983, 2984, 2985, 2986, 2987, 2988, 2989, 2990, 2991, 2992, 2993, 2994, 2995, 2996, 2997, 2998, 2999, 3000		



MKO
Planning and
Environmental
Consultants
Team Road, Galway
Ireland, H91 VW84
+353 (0) 91 735611
email: info@www.mkofireland.ie
Website: www.mkofireland.ie

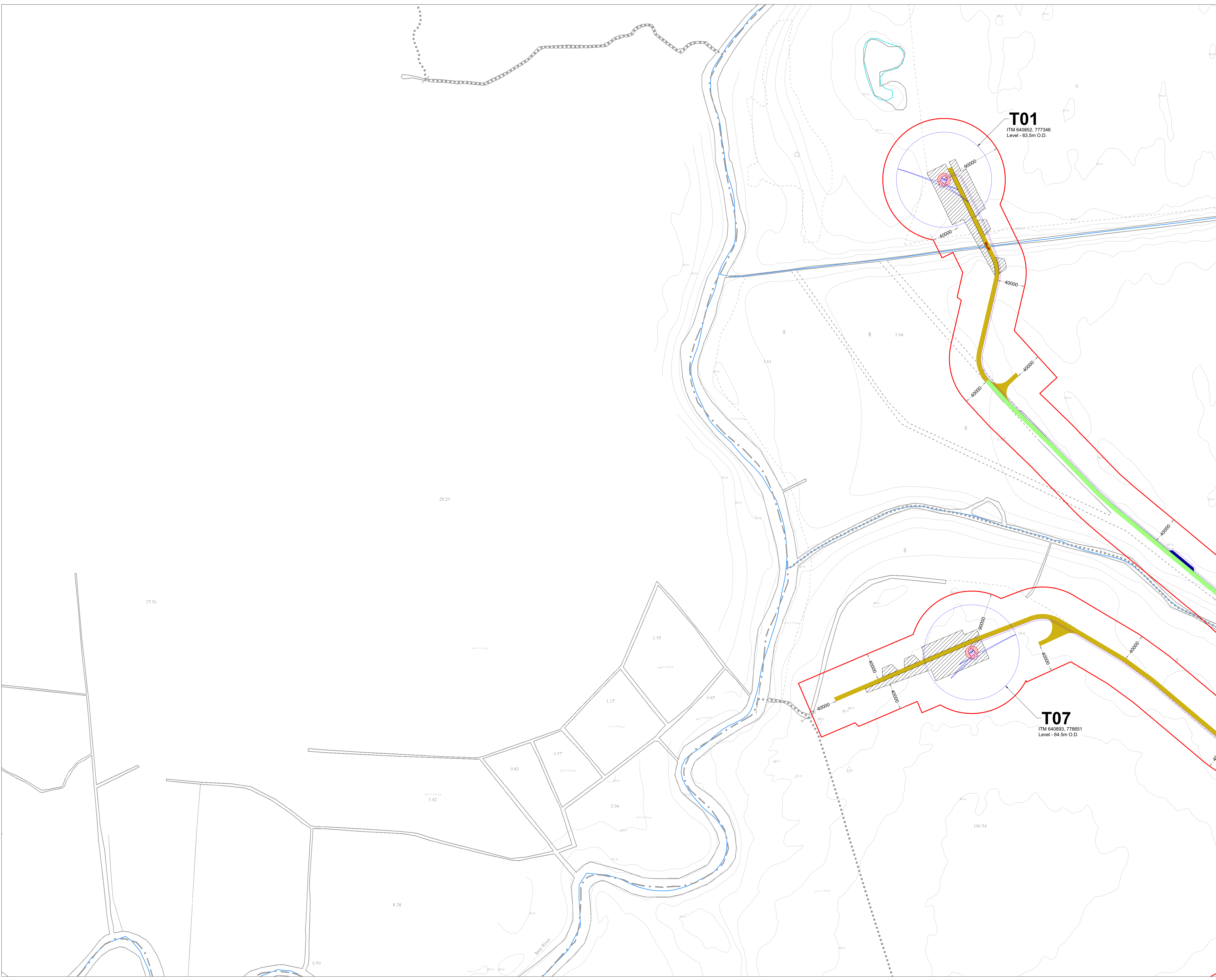

- Project Design Drawing Notes**
1. Drawings issued are for planning application purposes only.
 2. Drawings not to be used for construction/contract conditions.
 3. Copyright, all rights reserved. No part herewith may be copied or reproduced partially or wholly in any form whatsoever without the prior notice of the copyright owner McCarthy Keville O'Sullivan.
 4. Do not scale off this drawing. Figured metric dimensions only should be taken off this drawing.
 5. All contractors, whether main or sub-contractors, must visit the site and are responsible for taking and checking any and all dimensions and levels that relate to the works.
 6. The use of or reliance upon this drawing shall be deemed to be acceptance of these conditions of use unless otherwise agreed in writing, such written agreement to be sought from and issued by the copyright holder to the use or reliance upon this drawing.
 7. Layout plans show typical Turbine rotor diameter as per turbine drawing.
 8. Final levels may vary depending on local ground conditions.
 9. Exact location of cable/joint bay in the road corridor to be subject to ESB specifications and agreement with Westmeath County Council

- Drawing Legend**
- Planning Application Boundary
 - Existing Internal Road to be Upgraded
 - Proposed Road
 - Proposed New Crossing
 - Passing Bays
 - Crane Pad Hardstanding Area
 - Turbine Foundation
 - Turbine Sweep Area
 - Internal Electrical Cabling
 - River/Stream

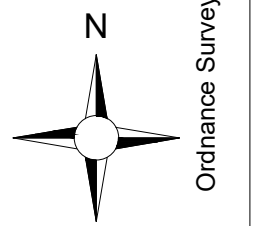

Ordnance Survey Ireland Licence No. CYAL5026757 © Ordnance Survey Ireland/Government of Ireland

DRAWING TITLE:
**Site Layout Plan
Sheet 1 of 24**

PROJECT TITLE:
Coole Wind Farm FI, Co. Westmeath

DRAWING BY: Joseph O Brien	CHECKED BY: Meabhann Crowe
PROJECT No.: 200445g	DRAWING No.: 200445g - 14 FI
SCALE: 1:2,500 @ A1	DATE: 27.10.2022

OS SHEET No.: 228, 229, 230, 231, 232, 233, 234, 235, 236, 242, 243, 247, 248, 249, 249A, 249B, 252, 253, 254, 255, 256, 262, 263, 263A, 263B, 269, 270, 271, 2702, 2708, 2709, 2770, 2771

MKO
Planning and
Environmental
Consultants
Tuam Road, Galway
Ireland: H91 VV8B4
+353 (0) 91 735611
email: info@www.mkoireland.ie
Website: www.mkoireland.ie

- Project Design Drawing Notes**
1. Drawings issued are for planning application purposes only.
 2. Drawings not to be used for construction/contract conditions.
 3. Copyright, all rights reserved. No part herewith may be copied or reproduced partially or wholly in any form whatsoever without the prior notice of the copyright owner McCarthy Keville O'Sullivan.
 4. Do not scale off this drawing. Figured metric dimensions only should be taken off this drawing.
 5. All contractors, whether main or sub-contractors, must visit the site and are responsible for taking and checking any and all dimensions and levels that relate to the works.
 6. The use of or reliance upon this drawing shall be deemed to be acceptance of these conditions of use unless otherwise agreed in writing, such written agreement to be sought from and issued by the copyright holder to the use or reliance upon this drawing.
 7. Layout plans show typical Turbine rotor diameter as per turbine drawing.
 8. Final levels may vary depending on local ground conditions.
 9. Exact location of cable/joint bay in the road corridor to be subject to ESB specifications and agreement with Westmeath County Council

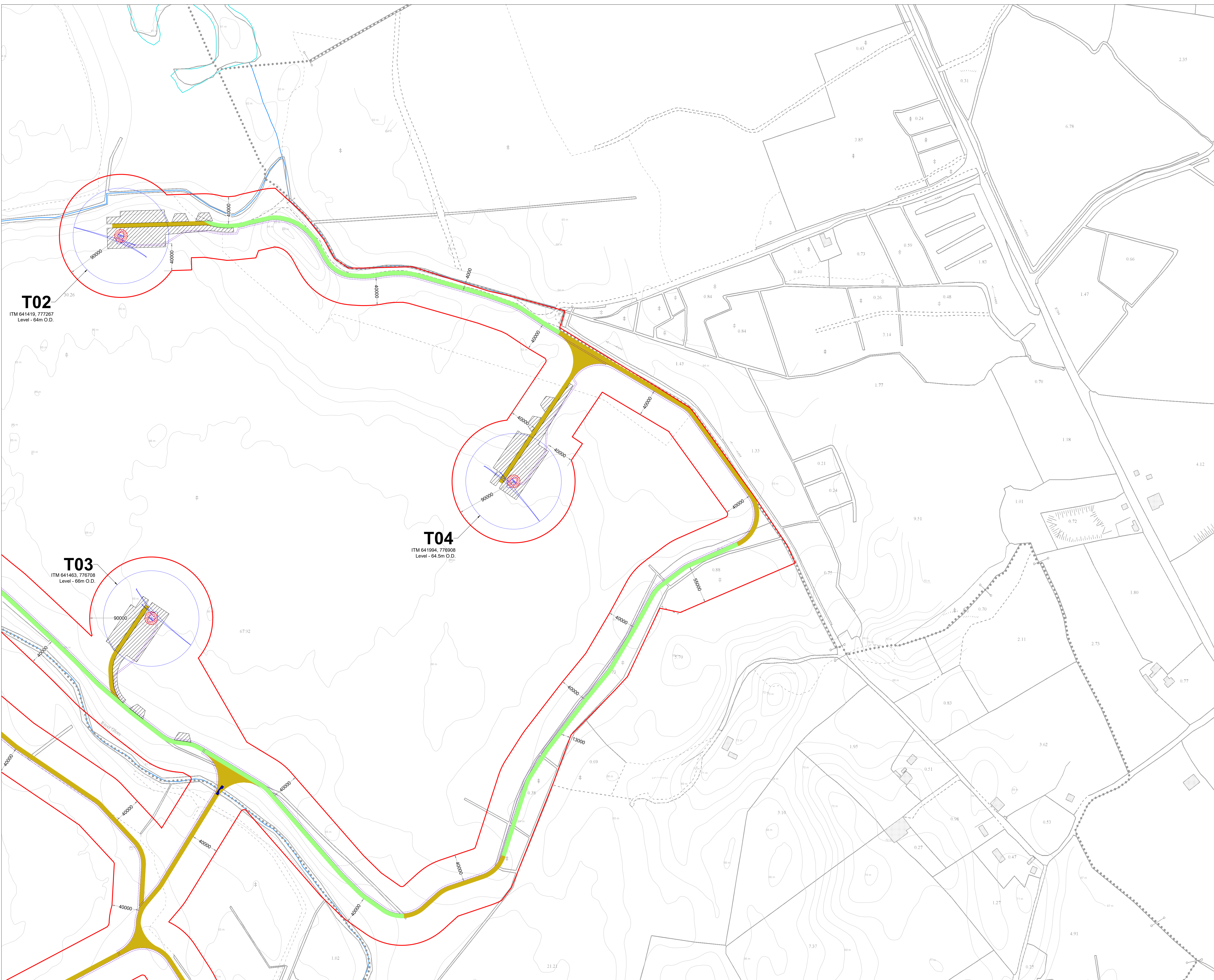

- Drawing Legend**
- Planning Application Boundary
 - Existing Internal Road to be Upgraded
 - Proposed Road
 - Existing Crossing for Upgrade
 - ▨ Crane Pad Hardstanding Area
 - ⊙ Turbine Foundation
 - ⊙ Turbine Sweep Area
 - Internal Electrical Cabling
 - River/Stream
 - Lakes

DRAWING TITLE:
**Site Layout Plan
 Sheet 2 of 24**

PROJECT TITLE:
Coole Wind Farm FI, Co. Westmeath

DRAWING BY: Joseph O Brien	CHECKED BY: Meabhann Crowe
PROJECT No.: 200445g	DRAWING No.: 200445g - 15 FI
SCALE: 1:2,500 @ A1	DATE: 27.10.2022

OS SHEET No.: 229, 230, 231, 232, 233, 234, 235, 236, 237, 238, 239, 240, 241, 242, 243, 244, 245, 246, 247, 248, 249, 250, 251, 252, 253, 254, 255, 256, 257, 258, 259, 260, 261, 262, 263, 264, 265, 266, 267, 268, 269, 270, 271, 272, 273, 274, 275, 276, 277, 278, 279, 280, 281, 282, 283, 284, 285, 286, 287, 288, 289, 290, 291, 292, 293, 294, 295, 296, 297, 298, 299, 300, 301, 302, 303, 304, 305, 306, 307, 308, 309, 310, 311, 312, 313, 314, 315, 316, 317, 318, 319, 320, 321, 322, 323, 324, 325, 326, 327, 328, 329, 330, 331, 332, 333, 334, 335, 336, 337, 338, 339, 340, 341, 342, 343, 344, 345, 346, 347, 348, 349, 350, 351, 352, 353, 354, 355, 356, 357, 358, 359, 360, 361, 362, 363, 364, 365, 366, 367, 368, 369, 370, 371, 372, 373, 374, 375, 376, 377, 378, 379, 380, 381, 382, 383, 384, 385, 386, 387, 388, 389, 390, 391, 392, 393, 394, 395, 396, 397, 398, 399, 400



MKO
 Planning and
 Environmental
 Consultants
 Tuam Road, Galway
 Ireland, H91 VM64
 +353 (0) 91 735611
 email: info@www.mkofireland.ie
 Website: www.mkofireland.ie

Ordnance Survey Ireland Licence No. CYAL50267517 © Ordnance Survey Ireland/Government of Ireland

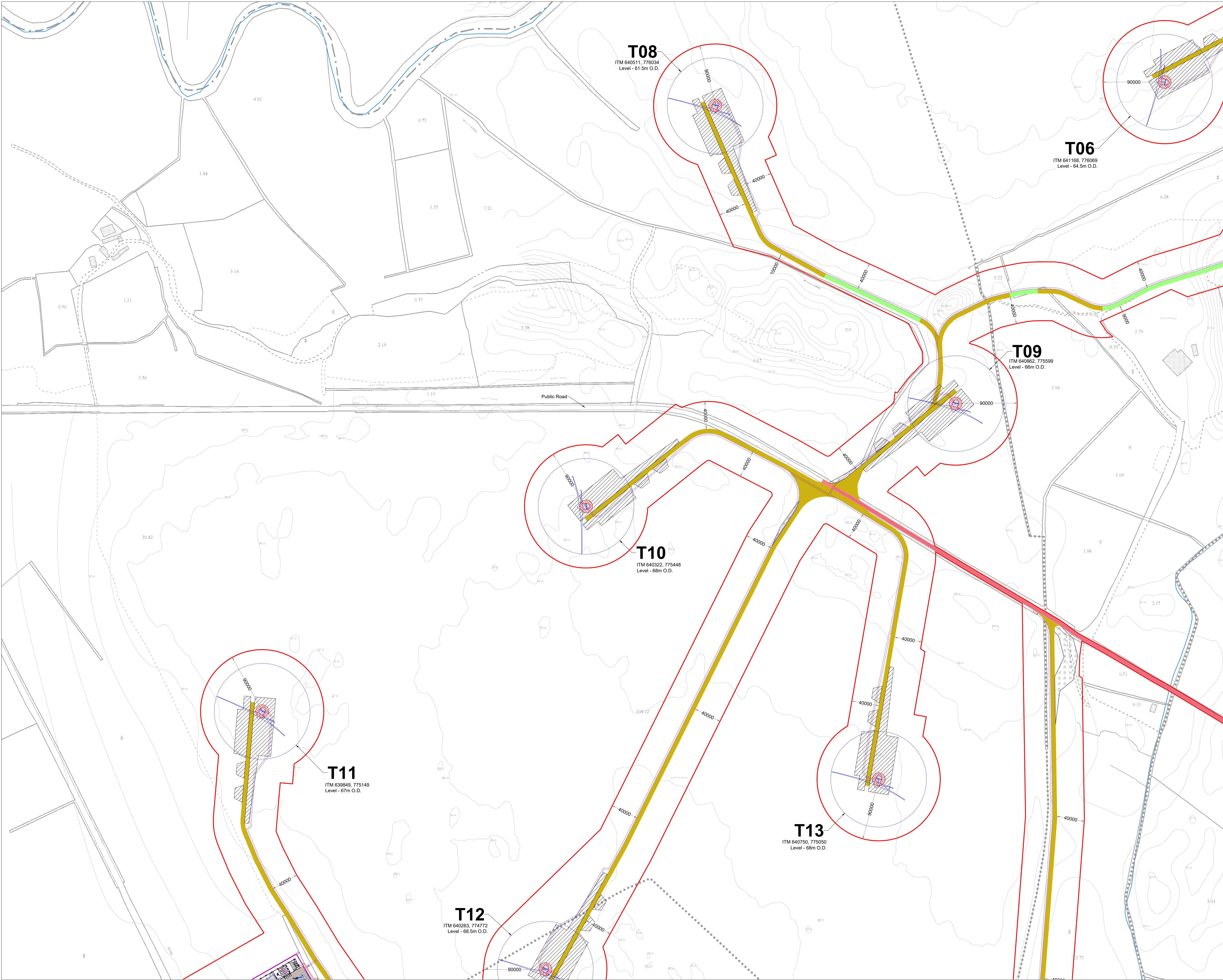

- Project Design Drawing Notes**
1. Drawings issued are for planning application purposes only.
 2. Drawings not to be used for construction/contract conditions.
 3. Copyright, all rights reserved. No part herewith may be copied or reproduced partially or wholly in any form whatsoever without the prior notice of the copyright owner McCarthy Keville O'Sullivan.
 4. Do not scale off this drawing. Figured metric dimensions only should be taken off this drawing.
 5. All contractors, whether main or sub-contractors, must visit the site and are responsible for taking and checking any and all dimensions and levels that relate to the works.
 6. The use of or reliance upon this drawing shall be deemed to be acceptance of these conditions of use unless otherwise agreed in writing, such written agreement to be sought from and issued by the copyright holder to the use or reliance upon this drawing.
 7. Layout plans show typical Turbine rotor diameter as per turbine drawing.
 8. Final levels may vary depending on local ground conditions.
 9. Exact location of cable/joint bay in the road corridor to be subject to ESB specifications and agreement with Westmeath County Council

- Drawing Legend**
- Planning Application Boundary
 - Existing Internal Road to be Upgraded
 - Existing External Road to be Upgraded
 - Proposed Road
 - Existing Crossing for Upgrade
 - ▨ Unbound Hardcore Surface
 - ▨ Crane Pad Hardstanding Area
 - ⊙ Turbine Foundation
 - ⊙ Turbine Sweep Area
 - Internal Electrical Cabling
 - Wind Farm Substation
 - River/Stream

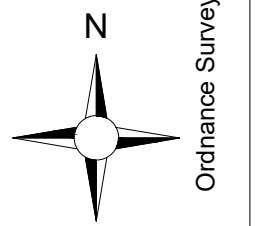

DRAWING TITLE:
**Site Layout Plan
 Sheet 3 of 24**

PROJECT TITLE:
Coole Wind Farm FI, Co. Westmeath

DRAWING BY: **Joseph O Brien** CHECKED BY: **Meabhann Crowe**
 PROJECT No.: **200445g** DRAWING No.: **200445g - 16 FI**
 SCALE: **1:2,500 @ A1** DATE: **27.10.2022**

OS SHEET No.:
 2106, 2107, 2238, 2239, 2300, 2301, 2302, 2303, 2363, 2364, 2365, 2366, 2425, 2426, 2427, 2428, 2493, 2494, 2495, 2496, 2562, 2563, 2564, 2565, 2626, 2627, 2628, 2629, 2700, 2701, 2702, 2766, 2768, 2770, 2771

MKO
 Planning and
 Environmental
 Consultants
 Tuam Road, Galway
 Ireland, H91 VM84
 +353 (0)91 735611
 email: info@www.mkoireland.ie
 Website: www.mkoireland.ie

Ordnance Survey Ireland Licence No. CYAL50267517 © Ordnance Survey Ireland/Government of Ireland

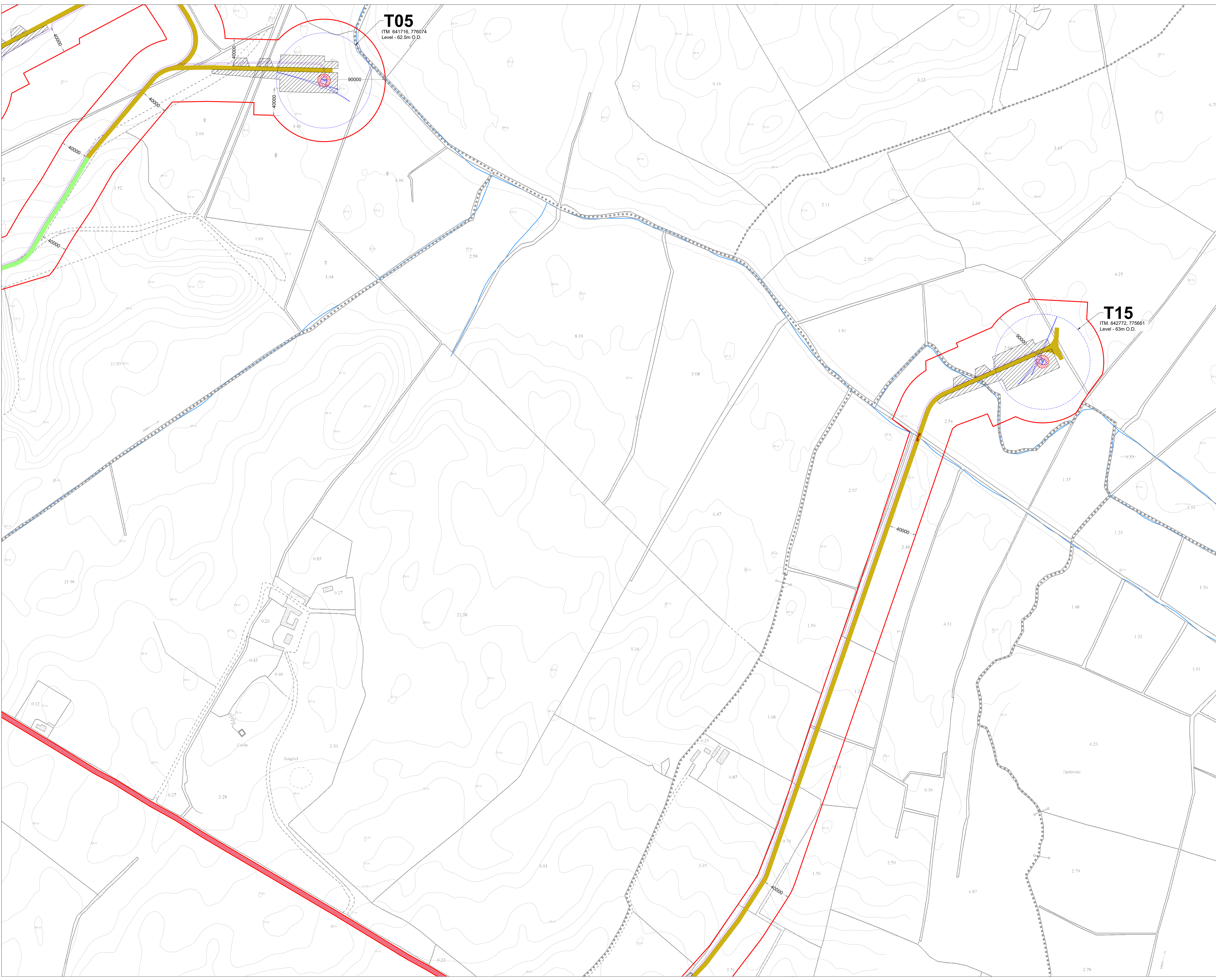

- Project Design Drawing Notes**
1. Drawings issued are for planning application purposes only.
 2. Drawings not to be used for construction/contract conditions.
 3. Copyright, all rights reserved. No part herewith may be copied or reproduced partially or wholly in any form whatsoever without the prior notice of the copyright owner McCarthy Keville O'Sullivan.
 4. Do not scale off this drawing. Figured metric dimensions only should be taken off this drawing.
 5. All contractors, whether main or sub-contractors, must visit the site and are responsible for taking and checking any and all dimensions and levels that relate to the works.
 6. The use of or reliance upon this drawing shall be deemed to be acceptance of these conditions of use unless otherwise agreed in writing, such written agreement to be sought from and issued by the copyright holder to the use or reliance upon this drawing.
 7. Layout plans show typical Turbine rotor diameter as per turbine drawing.
 8. Final levels may vary depending on local ground conditions.
 9. Exact location of cable/joint bay in the road corridor to be subject to ESB specifications and agreement with Westmeath County Council

- Drawing Legend**
- Planning Application Boundary
 - Existing Internal Road to be Upgraded
 - Existing External Road to be Upgraded
 - Proposed Road
 - Proposed New Crossing
 - ▨ Crane Pad Hardstanding Area
 - ⊙ Turbine Foundation
 - ⊙ Turbine Sweep Area
 - - - Internal Electrical Cabling
 - Wind Farm Substation
 - River/Stream

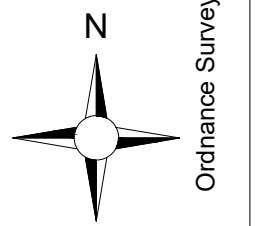

DRAWING TITLE:
**Site Layout Plan
 Sheet 4 of 24**

PROJECT TITLE:
Coole Wind Farm FI, Co. Westmeath

DRAWING BY: **Joseph O Brien** CHECKED BY: **Meabhann Crowe**

PROJECT No.: **200445g** DRAWING No.: **200445g - 17 FI**

SCALE: **1:2,500 @ A1** DATE: **27.10.2022**

OS SHEET No.:
 2016, 2017, 2018, 2019, 2020, 2021, 2022, 2023, 2024, 2025, 2026, 2027, 2028, 2029, 2030, 2031, 2032, 2033, 2034, 2035, 2036, 2037, 2038, 2039, 2040, 2041, 2042, 2043, 2044, 2045, 2046, 2047, 2048, 2049, 2050, 2051, 2052, 2053, 2054, 2055, 2056, 2057, 2058, 2059, 2060, 2061, 2062, 2063, 2064, 2065, 2066, 2067, 2068, 2069, 2070, 2071, 2072, 2073, 2074, 2075, 2076

MKO
 Planning and
 Environmental
 Consultants
 Tuam Road, Galway
 Ireland: H91 VN64
 +353 (0) 91 735611
 email: info@www.mkoireland.ie
 Website: www.mkoireland.ie

Ordnance Survey Ireland Licence No. CYAL502675176 © Ordnance Survey Ireland/Government of Ireland

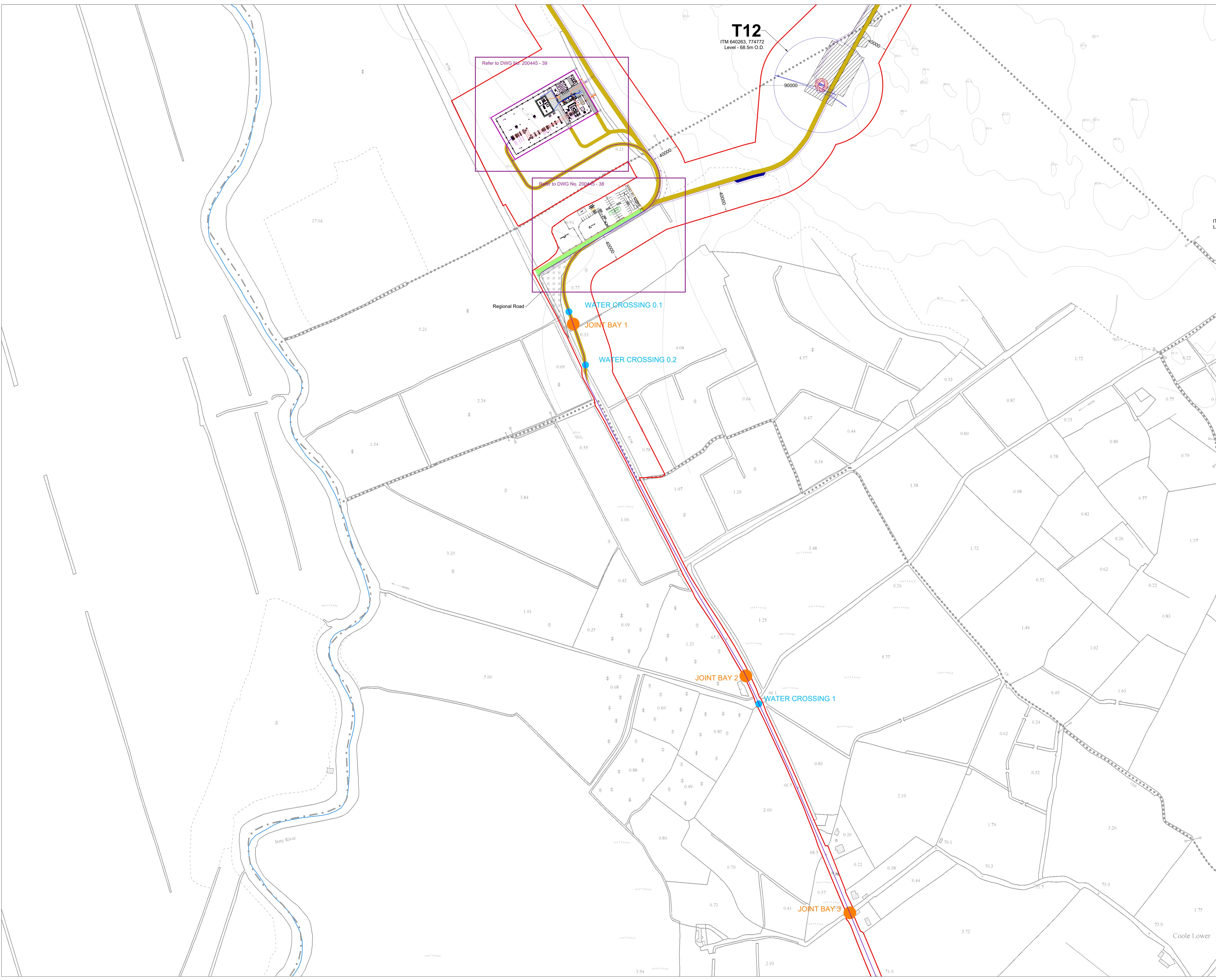

T12
 ITM 640263, 774772
 Level - 68.5m O.D.

Refer to DWG No. 200445 - 39

Refer to DWG No. 200445 - 38

- Project Design Drawing Notes**
1. Drawings issued are for planning application purposes only.
 2. Drawings not to be used for construction/contract conditions.
 3. Copyright, all rights reserved. No part herewith may be copied or reproduced partially or wholly in any form whatsoever without the prior notice of the copyright owner McCarthy Keville O'Sullivan.
 4. Do not scale off this drawing. Figured metric dimensions only should be taken off this drawing.
 5. All contractors, whether main or sub-contractors, must visit the site and are responsible for taking and checking any and all dimensions and levels that relate to the works.
 6. The use of or reliance upon this drawing shall be deemed to be acceptance of these conditions of use unless otherwise agreed in writing, such written agreement to be sought from and issued by the copyright holder to the use or reliance upon this drawing.
 7. Layout plans show typical Turbine rotor diameter as per turbine drawing.
 8. Final levels may vary depending on local ground conditions.
 9. Exact location of cable/joint bay in the road corridor to be subject to ESB specifications and agreement with Westmeath County Council

- Drawing Legend**
- Planning Application Boundary
 - Existing Internal Road to be Upgraded
 - Existing External Road to be Upgraded
 - Proposed Road
 - ▨ Unbound Hardcore Surface
 - ▨ Crane Pad Hardstanding Area
 - ⊙ Turbine Foundation
 - ⊙ Turbine Sweep Area
 - ⊙ Temporary Construction Compound
 - Internal Electrical Cabling
 - Grid Connection Route
 - Wind Farm Substation
 - ⊗ X Spot Height
 - Joint Bay
 - Watercrossing
 - River/Stream

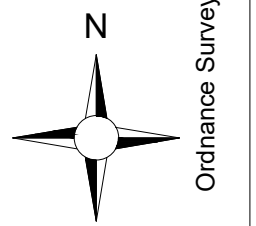

DRAWING TITLE:
**Site Layout Plan
 Sheet 5 of 24**

PROJECT TITLE:
Coolo Wind Farm FI, Co. Westmeath

DRAWING BY: **Joseph O'Brien** CHECKED BY: **Meabhann Crowe**

PROJECT No.: **200445g** DRAWING No.: **200445g - 18 FI**

SCALE: **1:2,500 @ A1** DATE: **27.10.2022**

OS SHEET No.:
 2016, 2017, 2018, 2019, 2020, 2021, 2022, 2023, 2024, 2025, 2026, 2027, 2028, 2029, 2030, 2031, 2032, 2033, 2034, 2035, 2036, 2037, 2038, 2039, 2040, 2041, 2042, 2043, 2044, 2045, 2046, 2047, 2048, 2049, 2050, 2051, 2052, 2053, 2054, 2055, 2056, 2057, 2058, 2059, 2060, 2061, 2062, 2063, 2064, 2065, 2066, 2067, 2068, 2069, 2070, 2071, 2072, 2073, 2074, 2075, 2076

MKO
 Planning and
 Environmental
 Consultants
 Tuam Road, Galway
 Ireland, H91 VM84
 +353 (0) 91 735611
 email: info@www.mkoireland.ie
 Website: www.mkoireland.ie

Ordnance Survey Ireland Licence No. CYAL50267517 © Ordnance Survey Ireland/Government of Ireland

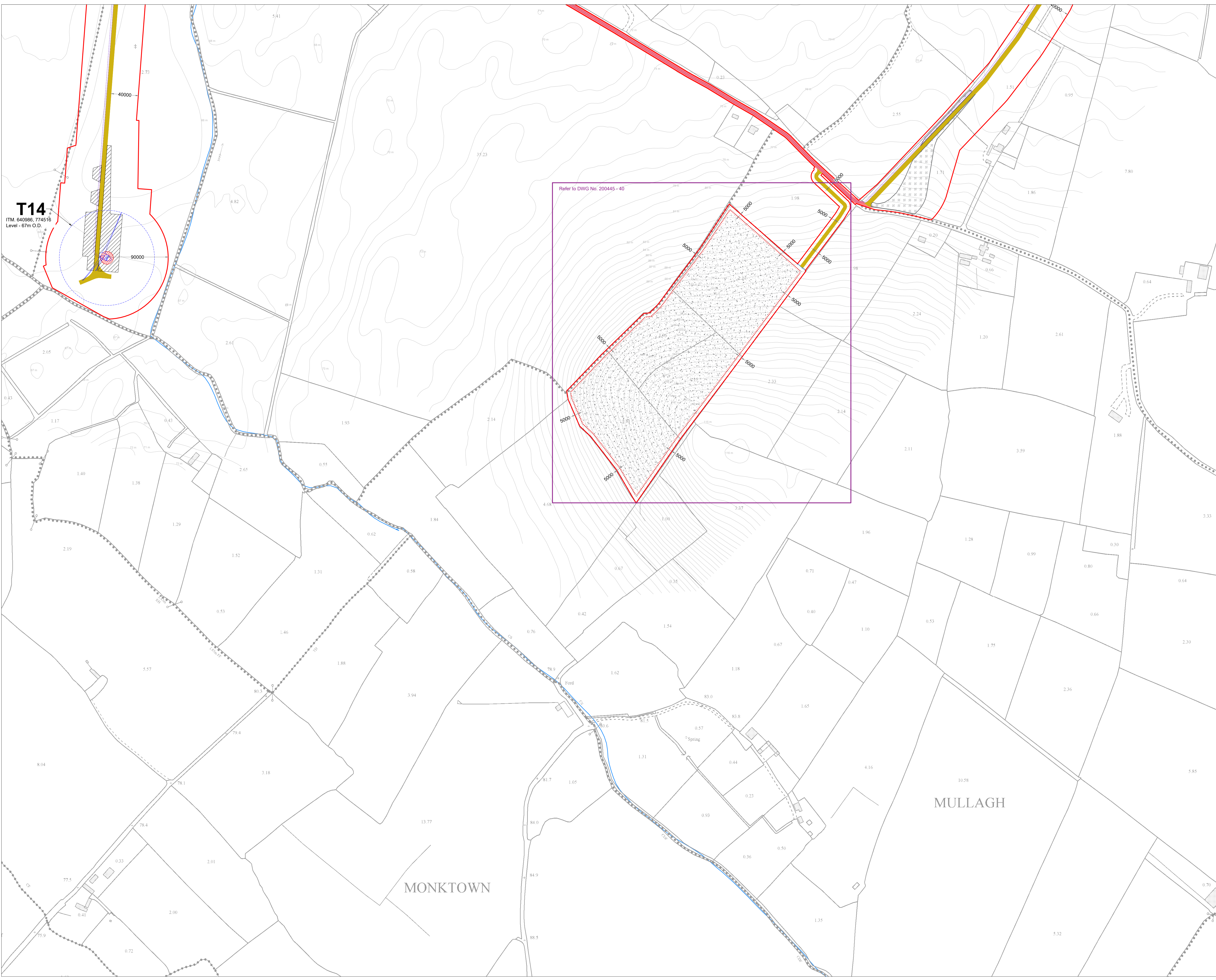

T14
 ITM: 640986, 774516
 Level - 67m O.D.

Refer to DWG No. 200445 - 40

- Project Design Drawing Notes**
1. Drawings issued are for planning application purposes only.
 2. Drawings not to be used for construction/contract conditions.
 3. Copyright, all rights reserved. No part herewith may be copied or reproduced partially or wholly in any form whatsoever without the prior notice of the copyright owner McCarthy Keville O'Sullivan.
 4. Do not scale off this drawing. Figured metric dimensions only should be taken off this drawing.
 5. All contractors, whether main or sub-contractors, must visit the site and are responsible for taking and checking any and all dimensions and levels that relate to the works.
 6. The use of or reliance upon this drawing shall be deemed to be acceptance of these conditions of use unless otherwise agreed in writing, such written agreement to be sought from and issued by the copyright holder to the use or reliance upon this drawing.
 7. Layout plans show typical Turbine rotor diameter as per turbine drawing.
 8. Final levels may vary depending on local ground conditions.
 9. Exact location of cable/joint bay in the road corridor to be subject to ESB specifications and agreement with Westmeath County Council

- Drawing Legend**
- Planning Application Boundary
 - Existing External Road to be Upgraded
 - Proposed Road
 - Unbound Hardcore Surface
 - Crane Pad Hardstanding Area
 - Turbine Foundation
 - Turbine Sweep Area
 - Borrow Pit
 - Internal Electrical Cabling
 - River/Stream

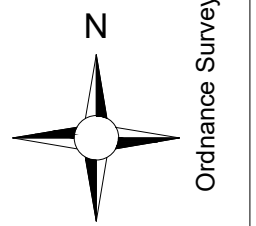

DRAWING TITLE:
**Site Layout Plan
 Sheet 6 of 24**

PROJECT TITLE:
Coole Wind Farm FI, Co. Westmeath

DRAWING BY: **Joseph O Brien** CHECKED BY: **Meabhann Crowe**
 PROJECT No.: **200445g** DRAWING No.: **200445g - 19 FI**
 SCALE: **1:2,500 @ A1** DATE: **27.10.2022**

OS SHEET No.:
 2406, 2407, 2408, 2409, 2410, 2411, 2412, 2413, 2414, 2415, 2416, 2417, 2418, 2419, 2420, 2421, 2422, 2423, 2424, 2425, 2426, 2427, 2428, 2429, 2430, 2431, 2432, 2433, 2434, 2435, 2436, 2437, 2438, 2439, 2440, 2441, 2442, 2443, 2444, 2445, 2446, 2447, 2448, 2449, 2450, 2451, 2452, 2453, 2454, 2455, 2456, 2457, 2458, 2459, 2460, 2461, 2462, 2463, 2464, 2465, 2466, 2467, 2468, 2469, 2470, 2471, 2472, 2473, 2474, 2475, 2476

MKO
 Planning and
 Environmental
 Consultants
 Tuam Road, Galway
 Ireland: H91 VM84
 +353 (0) 91 735611
 email: info@www.mkofireland.ie
 Website: www.mkofireland.ie

Ordnance Survey Ireland Licence No. CYAL50267517 © Ordnance Survey Ireland/Government of Ireland



- Project Design Drawing Notes**
1. Drawings issued are for planning application purposes only.
 2. Drawings not to be used for construction/contract conditions.
 3. Copyright, all rights reserved. No part herewith may be copied or reproduced partially or wholly in any form whatsoever without the prior notice of the copyright owner McCarthy Keville O'Sullivan.
 4. Do not scale off this drawing. Figured metric dimensions only should be taken off this drawing.
 5. All contractors, whether main or sub-contractors, must visit the site and are responsible for taking and checking any and all dimensions and levels that relate to the works.
 6. The use of or reliance upon this drawing shall be deemed to be acceptance of these conditions of use unless otherwise agreed in writing, such written agreement to be sought from and issued by the copyright holder to the use or reliance upon this drawing.
 7. Layout plans show typical Turbine rotor diameter as per turbine drawing.
 8. Final levels may vary depending on local ground conditions.
 9. Exact location of cable/joint bay in the road corridor to be subject to ESB specifications and agreement with Westmeath County Council

- Drawing Legend**
- Planning Application Boundary
 - Proposed Road
 - Unbound Hardcore Surface
 - Crossing Point for Landowners
 - Grid Connection Route
 - X Spot Height
 - Joint Bay
 - River/Stream

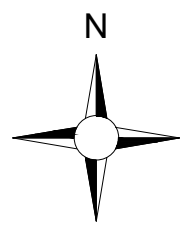

DRAWING TITLE:
**Site Layout Plan
 Sheet 7 of 24**

PROJECT TITLE:
Coole Wind Farm FI, Co. Westmeath

DRAWING BY: Joseph O'Brien	CHECKED BY: Meabhann Crowe
PROJECT No.: 200445g	DRAWING No.: 200445g - 20 FI
SCALE: 1:2,500 @ A1	DATE: 27.10.2022

OS SHEET No.: 228, 229, 230, 231, 232, 233, 234, 235, 236, 242, 243, 244, 245, 246, 247, 248, 249, 254, 255, 256, 257, 258, 259, 260, 261, 262, 263, 264, 265, 266, 267, 268, 269, 270, 271, 272, 273, 274, 275, 276, 277

MKO
 Planning and
 Environmental
 Consultants
 Tuam Road, Galway
 Ireland, H91 VM84
 +353 (0) 91 735611
 email: info@www.mkoireland.ie
 Website: www.mkoireland.ie

Ordnance Survey Ireland Licence No. CYAL50267517© Ordnance Survey Ireland/Government of Ireland

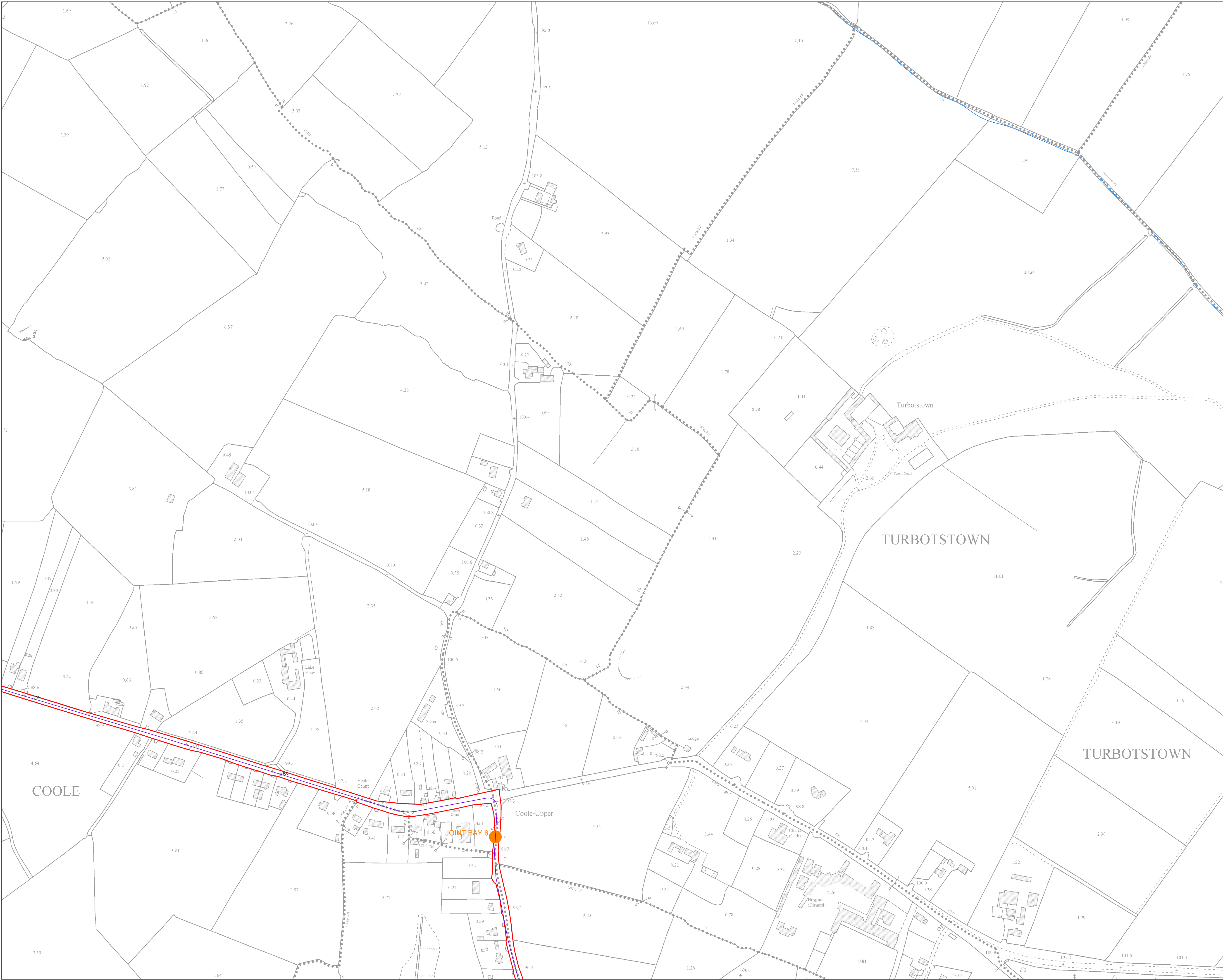

- Project Design Drawing Notes**
1. Drawings issued are for planning application purposes only.
 2. Drawings not to be used for construction/contract conditions.
 3. Copyright, all rights reserved. No part herewith may be copied or reproduced partially or wholly in any form whatsoever without the prior notice of the copyright owner McCarthy Keville O'Sullivan.
 4. Do not scale off this drawing. Figured metric dimensions only should be taken off this drawing.
 5. All contractors, whether main or sub-contractors, must visit the site and are responsible for taking and checking any and all dimensions and levels that relate to the works.
 6. The use of or reliance upon this drawing shall be deemed to be acceptance of these conditions of use unless otherwise agreed in writing, such written agreement to be sought from and issued by the copyright holder to the use or reliance upon this drawing.
 7. Layout plans show typical Turbine rotor diameter as per turbine drawing.
 8. Final levels may vary depending on local ground conditions.
 9. Exact location of cable/joint bay in the road corridor to be subject to ESB specifications and agreement with Westmeath County Council

Drawing Legend

- Planning Application Boundary
- Grid Connection Route
- X Spot Height
- Joint Bay

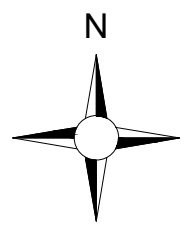

Ordnance Survey Ireland Licence No. CYAL50267517 © Ordnance Survey Ireland/Government of Ireland

DRAWING TITLE: Site Layout Plan Sheet 8 of 24	
PROJECT TITLE: Coole Wind Farm FI, Co. Westmeath	
DRAWING BY: Joseph O'Brien	CHECKED BY: Meabhann Crowe
PROJECT No.: 200445g	DRAWING No.: 200445g - 21 FI
SCALE: 1:2,500 @ A1	DATE: 27.10.2022
OS SHEET No.: <small>208, 209, 210, 211, 212, 213, 214, 215, 216, 217, 218, 219, 220, 221, 222, 223, 224, 225, 226, 227, 228, 229, 230, 231, 232, 233, 234, 235, 236, 237, 238, 239, 240, 241, 242, 243, 244, 245, 246, 247, 248, 249, 250, 251, 252, 253, 254, 255, 256, 257, 258, 259, 260, 261, 262, 263, 264, 265, 266, 267, 268, 269, 270, 271, 272, 273, 274, 275, 276, 277</small>	

MKO
Planning and
Environmental
Consultants
Tuam Road, Galway
Ireland, H91 VM84
+353 (0) 91 735611
email: info@www.mkofireland.ie
Website: www.mkofireland.ie

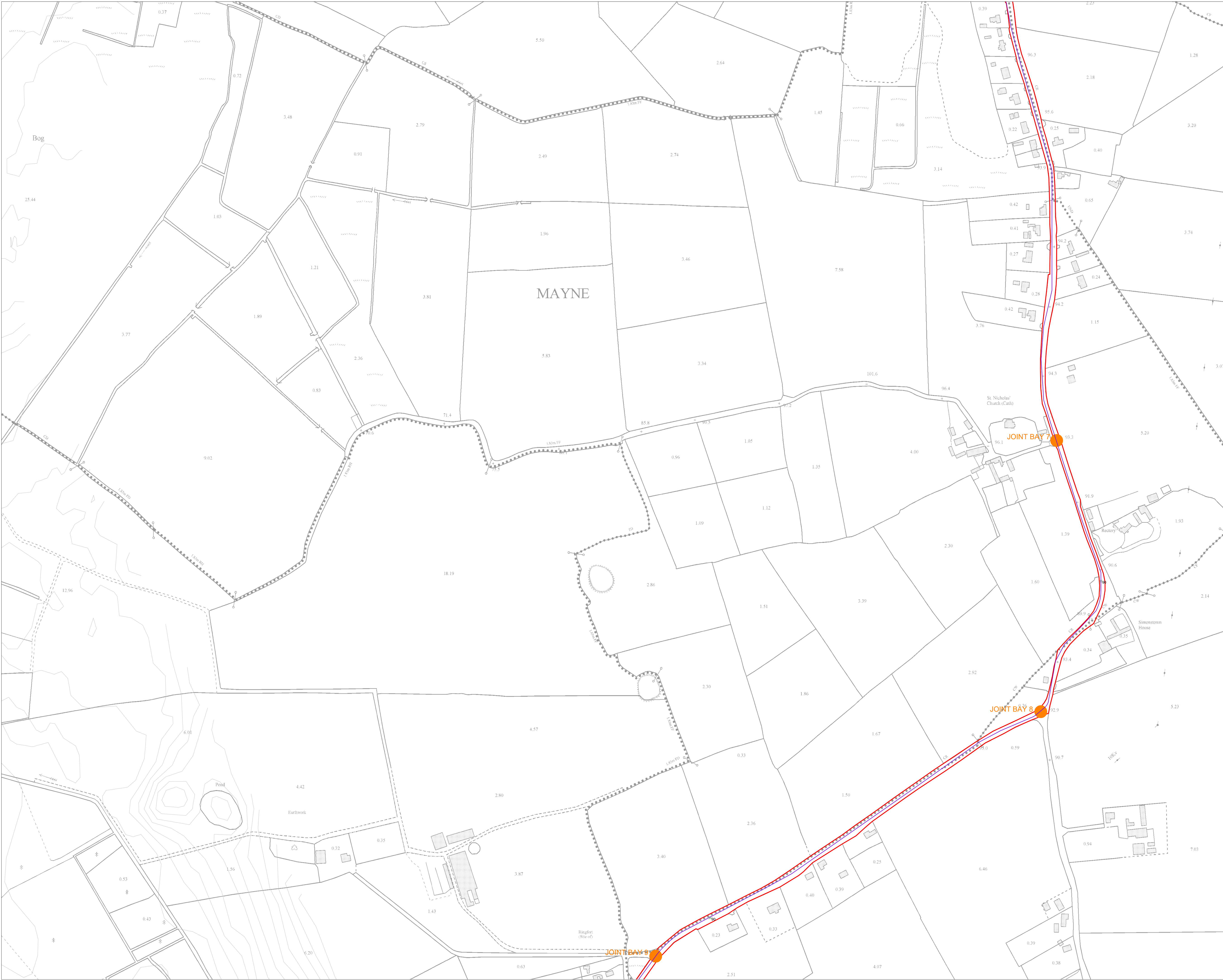

- Project Design Drawing Notes**
1. Drawings issued are for planning application purposes only.
 2. Drawings not to be used for construction/contract conditions.
 3. Copyright, all rights reserved. No part herewith may be copied or reproduced partially or wholly in any form whatsoever without the prior notice of the copyright owner McCarthy Keville O'Sullivan.
 4. Do not scale off this drawing. Figured metric dimensions only should be taken off this drawing.
 5. All contractors, whether main or sub-contractors, must visit the site and are responsible for taking and checking any and all dimensions and levels that relate to the works.
 6. The use of or reliance upon this drawing shall be deemed to be acceptance of these conditions of use unless otherwise agreed in writing, such written agreement to be sought from and issued by the copyright holder to the use or reliance upon this drawing.
 7. Layout plans show typical Turbine rotor diameter as per turbine drawing.
 8. Final levels may vary depending on local ground conditions.
 9. Exact location of cable/joint bay in the road corridor to be subject to ESB specifications and agreement with Westmeath County Council

- Drawing Legend**
- Planning Application Boundary
 - Grid Connection Route
 - X Spot Height
 - Joint Bay

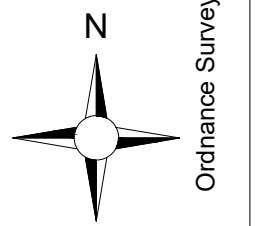

DRAWING TITLE:
**Site Layout Plan
 Sheet 13 of 24**

PROJECT TITLE:
Coole Wind Farm FI, Co. Westmeath

DRAWING BY: **Joseph O'Brien** CHECKED BY: **Meabhann Crowe**

PROJECT No.: **200445g** DRAWING No.: **200445g - 26 FI**

SCALE: **1:2,500 @ A1** DATE: **27.10.2022**

OS SHEET No.: 2006, 2007, 2008, 2009, 2010, 2011, 2012, 2013, 2014, 2015, 2016, 2017, 2018, 2019, 2020, 2021, 2022, 2023, 2024, 2025, 2026, 2027, 2028, 2029, 2030, 2031, 2032, 2033, 2034, 2035, 2036, 2037, 2038, 2039, 2040, 2041, 2042, 2043, 2044, 2045, 2046, 2047, 2048, 2049, 2050, 2051, 2052, 2053, 2054, 2055, 2056, 2057, 2058, 2059, 2060, 2061, 2062, 2063, 2064, 2065, 2066, 2067, 2068, 2069, 2070, 2071, 2072, 2073, 2074, 2075, 2076

MKO
 Planning and
 Environmental
 Consultants
 Tuam Road, Galway
 Ireland, H91 VM84
 +353 (0)91 735611
 email: info@www.mkoireland.ie
 Website: www.mkoireland.ie

Ordnance Survey Ireland Licence No. CYAL50267517 © Ordnance Survey Ireland/Government of Ireland



- Project Design Drawing Notes**
1. Drawings issued are for planning application purposes only.
 2. Drawings not to be used for construction/contract conditions.
 3. Copyright, all rights reserved. No part herewith may be copied or reproduced partially or wholly in any form whatsoever without the prior notice of the copyright owner McCarthy Keville O'Sullivan.
 4. Do not scale off this drawing. Figured metric dimensions only should be taken off this drawing.
 5. All contractors, whether main or sub-contractors, must visit the site and are responsible for taking and checking any and all dimensions and levels that relate to the works.
 6. The use of or reliance upon this drawing shall be deemed to be acceptance of these conditions of use unless otherwise agreed in writing, such written agreement to be sought from and issued by the copyright holder to the use or reliance upon this drawing.
 7. Layout plans show typical Turbine rotor diameter as per turbine drawing.
 8. Final levels may vary depending on local ground conditions.
 9. Exact location of cable/joint bay in the road corridor to be subject to ESB specifications and agreement with Westmeath County Council

- Drawing Legend**
- Planning Application Boundary
 - Grid Connection Route
 - X Spot Height
 - Joint Bay
 - Watercrossing

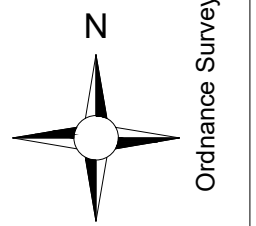

**Site Layout Plan
Sheet 14 of 24**

PROJECT TITLE:
Coole Wind Farm FI, Co. Westmeath

DRAWING BY: **Joseph O'Brien** CHECKED BY: **Meabhann Crowe**
 PROJECT No.: **200445g** DRAWING No.: **200445g - 27 FI**

SCALE: **1:2,500 @ A1** DATE: **27.10.2022**

OS SHEET No.: 2498, 2500, 2502, 2504, 2506, 2508, 2510, 2512, 2514, 2516, 2518, 2520, 2522, 2524, 2526, 2528, 2530, 2532, 2534, 2536, 2538, 2540, 2542, 2544, 2546, 2548, 2550, 2552, 2554, 2556, 2558, 2560, 2562, 2564, 2566, 2568, 2570, 2572, 2574, 2576, 2578, 2580, 2582, 2584, 2586, 2588, 2590, 2592, 2594, 2596, 2598, 2600, 2602, 2604, 2606, 2608, 2610, 2612, 2614, 2616, 2618, 2620, 2622, 2624, 2626, 2628, 2630, 2632, 2634, 2636, 2638, 2640, 2642, 2644, 2646, 2648, 2650, 2652, 2654, 2656, 2658, 2660, 2662, 2664, 2666, 2668, 2670, 2672, 2674, 2676, 2678, 2680, 2682, 2684, 2686, 2688, 2690, 2692, 2694, 2696, 2698, 2700, 2702, 2704, 2706, 2708, 2710, 2712, 2714, 2716, 2718, 2720, 2722, 2724, 2726, 2728, 2730, 2732, 2734, 2736, 2738, 2740, 2742, 2744, 2746, 2748, 2750, 2752, 2754, 2756, 2758, 2760, 2762, 2764, 2766, 2768, 2770, 2772, 2774, 2776, 2778, 2780, 2782, 2784, 2786, 2788, 2790, 2792, 2794, 2796, 2798, 2800, 2802, 2804, 2806, 2808, 2810, 2812, 2814, 2816, 2818, 2820, 2822, 2824, 2826, 2828, 2830, 2832, 2834, 2836, 2838, 2840, 2842, 2844, 2846, 2848, 2850, 2852, 2854, 2856, 2858, 2860, 2862, 2864, 2866, 2868, 2870, 2872, 2874, 2876, 2878, 2880, 2882, 2884, 2886, 2888, 2890, 2892, 2894, 2896, 2898, 2900, 2902, 2904, 2906, 2908, 2910, 2912, 2914, 2916, 2918, 2920, 2922, 2924, 2926, 2928, 2930, 2932, 2934, 2936, 2938, 2940, 2942, 2944, 2946, 2948, 2950, 2952, 2954, 2956, 2958, 2960, 2962, 2964, 2966, 2968, 2970, 2972, 2974, 2976, 2978, 2980, 2982, 2984, 2986, 2988, 2990, 2992, 2994, 2996, 2998, 3000, 3002, 3004, 3006, 3008, 3010, 3012, 3014, 3016, 3018, 3020, 3022, 3024, 3026, 3028, 3030, 3032, 3034, 3036, 3038, 3040, 3042, 3044, 3046, 3048, 3050, 3052, 3054, 3056, 3058, 3060, 3062, 3064, 3066, 3068, 3070, 3072, 3074, 3076, 3078, 3080, 3082, 3084, 3086, 3088, 3090, 3092, 3094, 3096, 3098, 3100, 3102, 3104, 3106, 3108, 3110, 3112, 3114, 3116, 3118, 3120, 3122, 3124, 3126, 3128, 3130, 3132, 3134, 3136, 3138, 3140, 3142, 3144, 3146, 3148, 3150, 3152, 3154, 3156, 3158, 3160, 3162, 3164, 3166, 3168, 3170, 3172, 3174, 3176, 3178, 3180, 3182, 3184, 3186, 3188, 3190, 3192, 3194, 3196, 3198, 3200, 3202, 3204, 3206, 3208, 3210, 3212, 3214, 3216, 3218, 3220, 3222, 3224, 3226, 3228, 3230, 3232, 3234, 3236, 3238, 3240, 3242, 3244, 3246, 3248, 3250, 3252, 3254, 3256, 3258, 3260, 3262, 3264, 3266, 3268, 3270, 3272, 3274, 3276, 3278, 3280, 3282, 3284, 3286, 3288, 3290, 3292, 3294, 3296, 3298, 3300, 3302, 3304, 3306, 3308, 3310, 3312, 3314, 3316, 3318, 3320, 3322, 3324, 3326, 3328, 3330, 3332, 3334, 3336, 3338, 3340, 3342, 3344, 3346, 3348, 3350, 3352, 3354, 3356, 3358, 3360, 3362, 3364, 3366, 3368, 3370, 3372, 3374, 3376, 3378, 3380, 3382, 3384, 3386, 3388, 3390, 3392, 3394, 3396, 3398, 3400, 3402, 3404, 3406, 3408, 3410, 3412, 3414, 3416, 3418, 3420, 3422, 3424, 3426, 3428, 3430, 3432, 3434, 3436, 3438, 3440, 3442, 3444, 3446, 3448, 3450, 3452, 3454, 3456, 3458, 3460, 3462, 3464, 3466, 3468, 3470, 3472, 3474, 3476, 3478, 3480, 3482, 3484, 3486, 3488, 3490, 3492, 3494, 3496, 3498, 3500, 3502, 3504, 3506, 3508, 3510, 3512, 3514, 3516, 3518, 3520, 3522, 3524, 3526, 3528, 3530, 3532, 3534, 3536, 3538, 3540, 3542, 3544, 3546, 3548, 3550, 3552, 3554, 3556, 3558, 3560, 3562, 3564, 3566, 3568, 3570, 3572, 3574, 3576, 3578, 3580, 3582, 3584, 3586, 3588, 3590, 3592, 3594, 3596, 3598, 3600, 3602, 3604, 3606, 3608, 3610, 3612, 3614, 3616, 3618, 3620, 3622, 3624, 3626, 3628, 3630, 3632, 3634, 3636, 3638, 3640, 3642, 3644, 3646, 3648, 3650, 3652, 3654, 3656, 3658, 3660, 3662, 3664, 3666, 3668, 3670, 3672, 3674, 3676, 3678, 3680, 3682, 3684, 3686, 3688, 3690, 3692, 3694, 3696, 3698, 3700, 3702, 3704, 3706, 3708, 3710, 3712, 3714, 3716, 3718, 3720, 3722, 3724, 3726, 3728, 3730, 3732, 3734, 3736, 3738, 3740, 3742, 3744, 3746, 3748, 3750, 3752, 3754, 3756, 3758, 3760, 3762, 3764, 3766, 3768, 3770, 3772, 3774, 3776, 3778, 3780, 3782, 3784, 3786, 3788, 3790, 3792, 3794, 3796, 3798, 3800, 3802, 3804, 3806, 3808, 3810, 3812, 3814, 3816, 3818, 3820, 3822, 3824, 3826, 3828, 3830, 3832, 3834, 3836, 3838, 3840, 3842, 3844, 3846, 3848, 3850, 3852, 3854, 3856, 3858, 3860, 3862, 3864, 3866, 3868, 3870, 3872, 3874, 3876, 3878, 3880, 3882, 3884, 3886, 3888, 3890, 3892, 3894, 3896, 3898, 3900, 3902, 3904, 3906, 3908, 3910, 3912, 3914, 3916, 3918, 3920, 3922, 3924, 3926, 3928, 3930, 3932, 3934, 3936, 3938, 3940, 3942, 3944, 3946, 3948, 3950, 3952, 3954, 3956, 3958, 3960, 3962, 3964, 3966, 3968, 3970, 3972, 3974, 3976, 3978, 3980, 3982, 3984, 3986, 3988, 3990, 3992, 3994, 3996, 3998, 4000, 4002, 4004, 4006, 4008, 4010, 4012, 4014, 4016, 4018, 4020, 4022, 4024, 4026, 4028, 4030, 4032, 4034, 4036, 4038, 4040, 4042, 4044, 4046, 4048, 4050, 4052, 4054, 4056, 4058, 4060, 4062, 4064, 4066, 4068, 4070, 4072, 4074, 4076, 4078, 4080, 4082, 4084, 4086, 4088, 4090, 4092, 4094, 4096, 4098, 4100, 4102, 4104, 4106, 4108, 4110, 4112, 4114, 4116, 4118, 4120, 4122, 4124, 4126, 4128, 4130, 4132, 4134, 4136, 4138, 4140, 4142, 4144, 4146, 4148, 4150, 4152, 4154, 4156, 4158, 4160, 4162, 4164, 4166, 4168, 4170, 4172, 4174, 4176, 4178, 4180, 4182, 4184, 4186, 4188, 4190, 4192, 4194, 4196, 4198, 4200, 4202, 4204, 4206, 4208, 4210, 4212, 4214, 4216, 4218, 4220, 4222, 4224, 4226, 4228, 4230, 4232, 4234, 4236, 4238, 4240, 4242, 4244, 4246, 4248, 4250, 4252, 4254, 4256, 4258, 4260, 4262, 4264, 4266, 4268, 4270, 4272, 4274, 4276, 4278, 4280, 4282, 4284, 4286, 4288, 4290, 4292, 4294, 4296, 4298, 4300, 4302, 4304, 4306, 4308, 4310, 4312, 4314, 4316, 4318, 4320, 4322, 4324, 4326, 4328, 4330, 4332, 4334, 4336, 4338, 4340, 4342, 4344, 4346, 4348, 4350, 4352, 4354, 4356, 4358, 4360, 4362, 4364, 4366, 4368, 4370, 4372, 4374, 4376, 4378, 4380, 4382, 4384, 4386, 4388, 4390, 4392, 4394, 4396, 4398, 4400, 4402, 4404, 4406, 4408, 4410, 4412, 4414, 4416, 4418, 4420, 4422, 4424, 4426, 4428, 4430, 4432, 4434, 4436, 4438, 4440, 4442, 4444, 4446, 4448, 4450, 4452, 4454, 4456, 4458, 4460, 4462, 4464, 4466, 4468, 4470, 4472, 4474, 4476, 4478, 4480, 4482, 4484, 4486, 4488, 4490, 4492, 4494, 4496, 4498, 4500, 4502, 4504, 4506, 4508, 4510, 4512, 4514, 4516, 4518, 4520, 4522, 4524, 4526, 4528, 4530, 4532, 4534, 4536, 4538, 4540, 4542, 4544, 4546, 4548, 4550, 4552, 4554, 4556, 4558, 4560, 4562, 4564, 4566, 4568, 4570, 4572, 4574, 4576, 4578, 4580, 4582, 4584, 4586, 4588, 4590, 4592, 4594, 4596, 4598, 4600, 4602, 4604, 4606, 4608, 4610, 4612, 4614, 4616, 4618, 4620, 4622, 4624, 4626, 4628, 4630, 4632, 4634, 4636, 4638, 4640, 4642, 4644, 4646, 4648, 4650, 4652, 4654, 4656, 4658, 4660, 4662, 4664, 4666, 4668, 4670, 4672, 4674, 4676, 4678, 4680, 4682, 4684, 4686, 4688, 4690, 4692, 4694, 4696, 4698, 4700, 4702, 4704, 4706, 4708, 4710, 4712, 4714, 4716, 4718, 4720, 4722, 4724, 4726, 4728, 4730, 4732, 4734, 4736, 4738, 4740, 4742, 4744, 4746, 4748, 4750, 4752, 4754, 4756, 4758, 4760, 4762, 4764, 4766, 4768, 4770, 4772, 4774, 4776, 4778, 4780, 4782, 4784, 4786, 4788, 4790, 4792, 4794, 4796, 4798, 4800, 4802, 4804, 4806, 4808, 4810, 4812, 4814, 4816, 4818, 4820, 4822, 4824, 4826, 4828, 4830, 4832, 4834, 4836, 4838, 4840, 4842, 4844, 4846, 4848, 4850, 4852, 4854, 4856, 4858, 4860, 4862, 4864, 4866, 4868, 4870, 4872, 4874, 4876, 4878, 4880, 4882, 4884, 4886, 4888, 4890, 4892, 4894, 4896, 4898, 4900, 4902, 4904, 4906, 4908, 4910, 4912, 4914, 4916, 4918, 4920, 4922, 4924, 4926, 4928, 4930, 4932, 4934, 4936, 4938, 4940, 4942, 4944, 4946, 4948, 4950, 4952, 4954, 4956, 4958, 4960, 4962, 4964, 4966, 4968, 4970, 4972, 4974, 4976, 4978, 4980, 4982, 4984, 4986, 4988, 4990, 4992, 4994, 4996, 4998, 5000, 5002, 5004, 5006, 5008, 5010, 5012, 5014, 5016, 5018, 5020, 5022, 5024, 5026, 5028, 5030, 5032, 5034, 5036, 5038, 5040, 5042, 5044, 5046, 5048, 5050, 5052, 5054, 5056, 5058, 5060, 5062, 5064, 5066, 5068, 5070, 5072, 5074, 5076, 5078, 5080, 5082, 5084, 5086, 5088, 5090, 5092, 5094, 5096, 5098, 5100, 5102, 5104, 5106, 5108, 5110, 5112, 5114, 5116, 5118, 5120, 5122, 5124, 5126, 5128, 5130, 5132, 5134, 5136, 5138, 5140, 5142, 5144, 5146, 5148, 5150, 5152, 5154, 5156, 5158, 5160, 5162, 5164, 5166, 5168, 5170, 5172, 5174, 5176, 5178, 5180, 5182, 5184, 5186, 5188, 5190, 5192, 5194, 5196, 5198, 5200, 5202, 5204, 5206, 5208, 5210, 5212, 5214, 5216, 5218, 5220, 5222, 5224, 5226, 5228, 5230, 5232, 5234, 5236, 5238, 5240, 5242, 5244, 5246, 5248, 5250, 5252, 5254, 5256, 5258, 5260, 5262, 5264, 5266, 5268, 5270, 5272, 5274, 5276, 5278, 5280, 5282, 5284, 5286, 5288, 5290, 5292, 5294, 5296, 5298, 5300, 5302, 5304, 5306, 5308, 5310, 5312, 5314, 5316, 5318, 5320, 5322, 5324, 5326, 5328, 5330, 5332, 5334, 5336, 5338, 5340, 5342, 5344, 5346, 5348, 5350, 5352, 5354, 5356, 5358, 5360, 5362, 5364, 5366, 5368, 5370, 5372, 5374, 5376, 5378, 5380, 5382, 5384, 5386, 5388, 5390, 5392, 5394, 5396, 5398, 5400, 5402, 5404, 5406, 5408, 5410, 5412, 5414, 5416, 5418, 5420, 5422, 5424, 5426, 5428, 5430, 5432, 5434, 5436, 5438, 5440, 5442, 5444, 5446, 5448, 5450, 5452, 5454, 5456, 5458, 5460, 5462, 5464, 5466, 5468, 5470, 5472, 5474, 5476, 5478, 5480, 5482, 5484, 5486, 5488, 5490, 5492, 5494, 5496, 5498, 5500, 5502, 5504, 5506, 5508, 5510, 5512, 5514, 5516, 5518, 5520, 5522, 5524, 5526, 5528, 5530, 5532, 5534, 5536, 5538, 5540, 5542, 5544, 5546, 5548, 5550, 5552, 5554, 5556, 5558, 5560, 5562, 5564, 5566, 5568, 5570, 5572, 5574, 5576, 5578, 5580, 5582, 5584, 5586, 5588, 5590, 5592, 5594, 5596, 5598, 5600, 5602, 5604, 5606, 5608, 5610, 5612, 5614, 5616, 5618, 5620, 5622, 5624, 5626, 5628, 5630, 5632, 5634, 5636, 5638, 5640, 5642, 5644, 5646, 5648, 5650, 5652, 5654, 5656, 5658, 5660, 5662, 5664, 5666, 5668, 5670, 5672, 5674, 5676, 5678, 5680, 5682, 5684, 5686, 5688, 5690, 5692, 5694, 5696, 5698, 5700, 5702, 5704, 5706, 5708, 5710, 5712, 5714, 5716, 5718, 5720, 5722, 5724, 5726, 5728, 5730, 5732, 5734, 5736, 5738, 5740, 5742, 5744, 5746, 5748, 5750, 5752, 5754, 5756, 5758, 5760, 5762, 5764, 5766, 5768, 5770, 5772, 5774, 5776, 5778, 5780, 5782, 5784, 5786, 5788, 5790, 5792, 5794, 5796, 5798, 5800, 5802, 5804, 5806, 5808, 5810, 5812, 5814, 5816, 5818, 5820, 5822, 5824, 5826, 5828, 5830, 5832, 5834, 5836, 5838, 5840, 5842, 5844, 5846, 5848, 5850, 5852, 5854, 5856, 5858, 5860, 5862, 5864, 5866, 5868, 5870, 5872, 5874, 5876, 5878, 5880, 5882, 5884, 5886, 5888, 5890, 5892, 5894, 5896, 5898, 5900, 5902, 5904, 5906, 5908, 5910, 5912, 5914, 5916, 5918, 5920, 5922, 5924, 5926, 5928, 5930, 5932, 5934, 5936, 5938, 5940, 5942, 5944, 5946, 5948, 5950, 5952, 5954, 5956, 5958, 5960, 5962, 5964, 5966, 5968, 5970, 5972, 5974, 5976, 5978, 5980, 5982, 5984, 5986, 5988, 5990, 5992, 5994, 5996, 5998, 6000, 6002, 6004, 6006, 6008, 6010, 6012, 6014, 6016, 6018, 6020, 6022, 6024, 6026, 6028, 6030, 6032, 6034, 6036, 6038, 6040, 6042, 6044, 6046, 6048, 6050, 6052, 6054, 6056, 6058, 6060, 6062, 6064, 6066, 6068, 6070, 6072, 6074, 6076, 6078, 6080, 6082, 6084, 6086, 6088, 6090, 6092, 6094, 6096, 6098, 6100, 6102, 6104, 6106, 6108, 6110, 6112, 6114, 6116, 6118, 6120, 6122, 6124, 6126, 6128, 6130, 6132, 6134, 6136, 6138, 6140, 6142, 6144, 6146, 6148, 6150, 6152, 6154, 6156, 6158, 6160, 6162, 6164, 6166, 6168, 6170, 6172, 6174, 6176, 6178, 6180, 6182, 6184, 6186, 6188, 6190, 6192, 6194, 6196, 6198, 6200, 6202, 6204, 6206, 6208, 6210, 6212, 6214, 6216, 6218, 6220, 6222, 6224, 6226, 6228, 6230, 6232, 6234, 6236, 6238, 6240, 6242, 6244, 6246, 6248, 6250, 6252, 6254, 6256, 6258, 6260, 6262, 6264, 6266, 6268, 6270, 6272, 6274, 6276, 6278, 6280, 6282, 6284, 6286, 6288, 6290, 6292, 6294, 6296, 6298, 6300, 6302, 6304, 6306, 6308, 6310, 6312, 6314, 6316, 6318, 6320, 6322, 6324, 6326, 6328, 6330, 6332, 6

Project Design Drawing Notes

1. Drawings issued are for planning application purposes only.
2. Drawings not to be used for construction/contract conditions.
3. Copyright, all rights reserved. No part hereof may be copied or reproduced partially or wholly in any form whatsoever without the prior notice of the copyright owner McCarthy Keville O'Sullivan.
4. Do not scale off this drawing. Figured metric dimensions only should be taken off this drawing.
5. All contractors, whether main or sub-contractors, must visit the site and are responsible for taking and checking any and all dimensions and levels that relate to the works.
6. The use of or reliance upon this drawing shall be deemed to be acceptance of these conditions of use unless otherwise agreed in writing, such written agreement to be sought from and issued by the copyright holder to the use or reliance upon this drawing.
7. Layout plans show typical Turbine rotor diameter as per turbine drawing.
8. Final levels may vary depending on local ground conditions.
9. Exact location of cable/joint bay in the road corridor to be subject to ESB specifications and agreement with Westmeath County Council

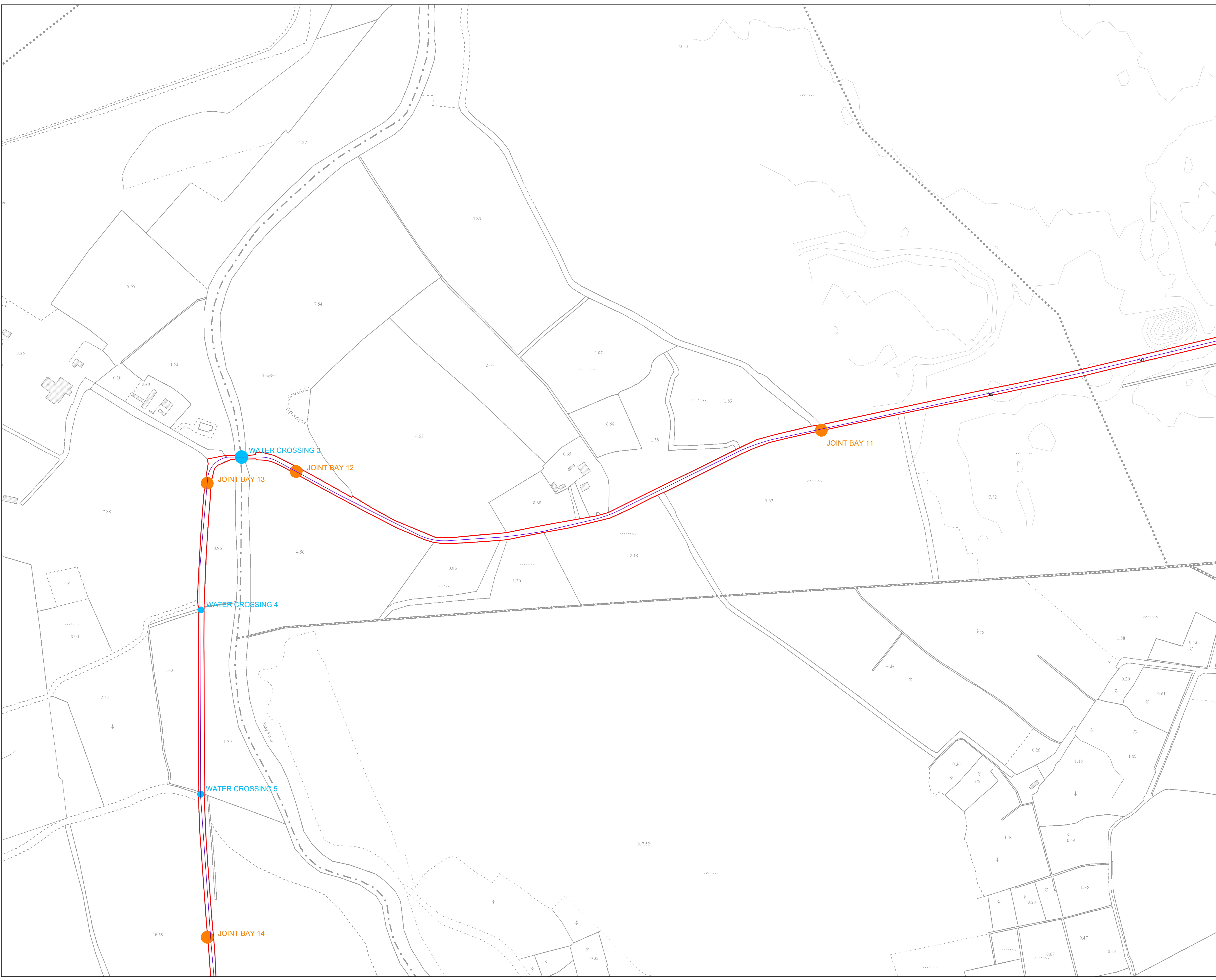

Drawing Legend

- Planning Application Boundary
- Grid Connection Route
- X Spot Height
- Joint Bay
- Watercrossing

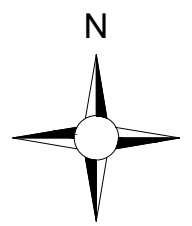

Ordnance Survey Ireland Licence No. CYAL50267517© Ordnance Survey Ireland/Government of Ireland

DRAWING TITLE: Site Layout Plan Sheet 15 of 24	
PROJECT TITLE: Coole Wind Farm FI, Co. Westmeath	
DRAWING BY: Joseph O'Brien	CHECKED BY: Meabhann Crowe
PROJECT No.: 200445g	DRAWING No.: 200445g - 28 FI
SCALE: 1:2,500 @ A1	DATE: 27.10.2022
OS SHEET No.: 2006, 2007, 2008, 2009, 2010, 2011, 2012, 2013, 2014, 2015, 2016, 2017, 2018, 2019, 2020, 2021, 2022, 2023, 2024, 2025, 2026, 2027, 2028, 2029, 2030, 2031, 2032, 2033, 2034, 2035, 2036, 2037, 2038, 2039, 2040, 2041, 2042, 2043, 2044, 2045, 2046, 2047, 2048, 2049, 2050, 2051, 2052, 2053, 2054, 2055, 2056, 2057, 2058, 2059, 2060, 2061, 2062, 2063, 2064, 2065, 2066, 2067, 2068, 2069, 2070, 2071, 2072, 2073, 2074, 2075, 2076	

MKO
Planning and
Environmental
Consultants
Tuam Road, Galway
Ireland, H91 VM84
+353 (0) 91 735611
email: info@www.mkoireland.ie
Website: www.mkoireland.ie

Project Design Drawing Notes

1. Drawings issued are for planning application purposes only.
2. Drawings not to be used for construction/contract conditions.
3. Copyright, all rights reserved. No part hereof may be copied or reproduced partially or wholly in any form whatsoever without the prior notice of the copyright owner McCarthy Keville O'Sullivan.
4. Do not scale off this drawing. Figured metric dimensions only should be taken off this drawing.
5. All contractors, whether main or sub-contractors, must visit the site and are responsible for taking and checking any and all dimensions and levels that relate to the works.
6. The use of or reliance upon this drawing shall be deemed to be acceptance of these conditions of use unless otherwise agreed in writing, such written agreement to be sought from and issued by the copyright holder to the use or reliance upon this drawing.
7. Layout plans show typical Turbine rotor diameter as per turbine drawing.
8. Final levels may vary depending on local ground conditions.
9. Exact location of cable/joint bay in the road corridor to be subject to ESB specifications and agreement with Westmeath County Council

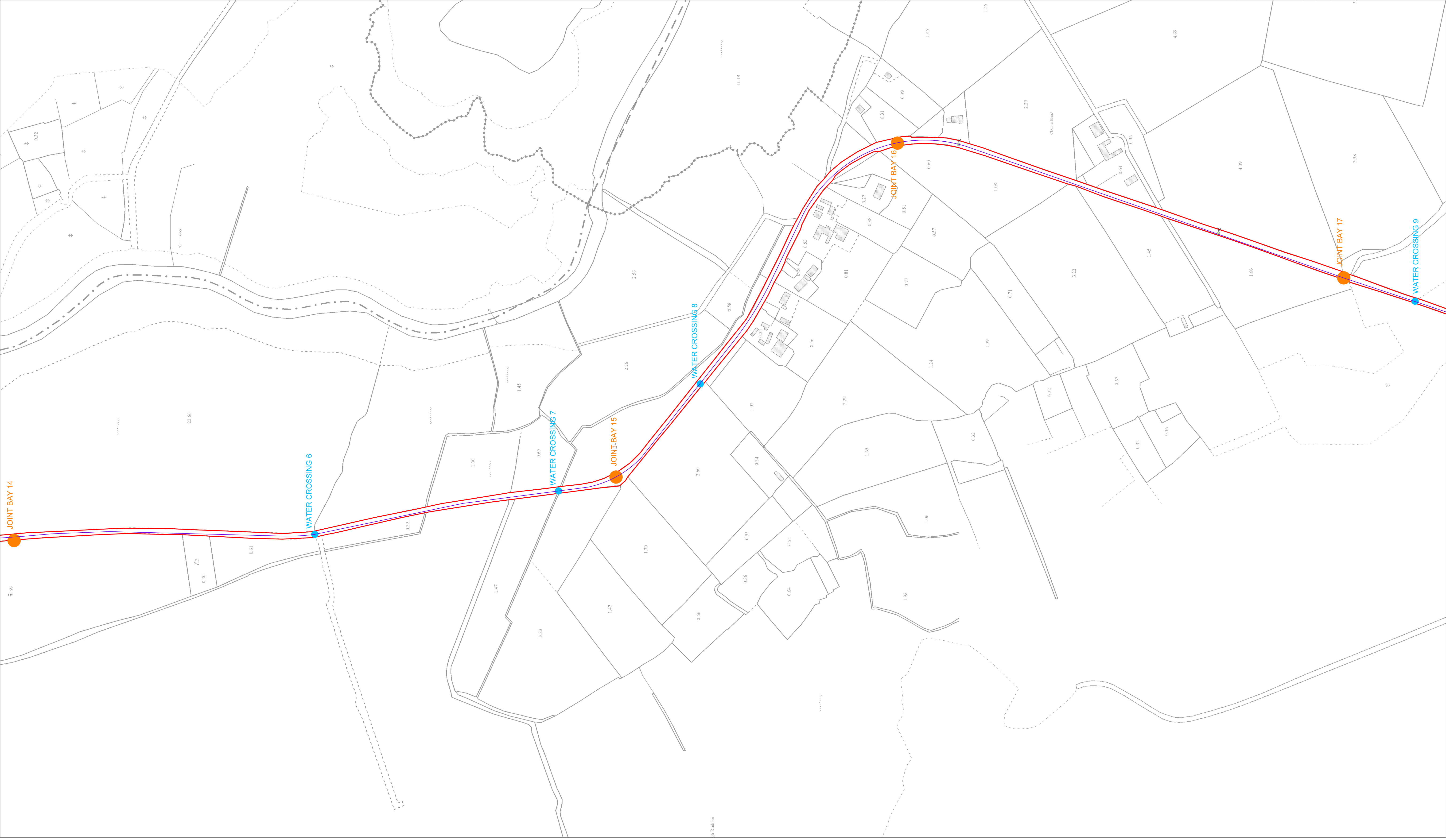

Drawing Legend

- Planning Application Boundary
- Grid Connection Route
- X Spot Height
- Joint Bay
- Watercrossing

Ordnance Survey Ireland Licence No. CYAL50267517 © Ordnance Survey Ireland/Government of Ireland

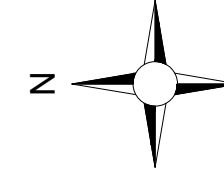

DRAWING TITLE
Site Layout Plan
Sheet 16 of 24

PROJECT TITLE
Coolo Wind Farm FI, Co. Westmeath

DRAWING BY
Joseph O'Brien

CHECKED BY
Meabhann Crowe

PROJECT No.
200445g - 29 FI

DRAWING No.
200445g - 29 FI

SCALE
1:2,500 @ A1

DATE
27.10.2022

OS SHEET No.:
 2004, 2005, 2006, 2007, 2008, 2009, 2010, 2011, 2012, 2013, 2014, 2015, 2016, 2017, 2018, 2019, 2020, 2021, 2022, 2023, 2024, 2025, 2026, 2027, 2028, 2029, 2030, 2031, 2032, 2033, 2034, 2035, 2036, 2037, 2038, 2039, 2040, 2041, 2042, 2043, 2044, 2045, 2046, 2047, 2048, 2049, 2050, 2051, 2052, 2053, 2054, 2055, 2056, 2057, 2058, 2059, 2060, 2061, 2062, 2063, 2064, 2065, 2066, 2067, 2068, 2069, 2070, 2071, 2072, 2073, 2074, 2075, 2076, 2077, 2078, 2079, 2080, 2081, 2082, 2083, 2084, 2085, 2086, 2087, 2088, 2089, 2090, 2091, 2092, 2093, 2094, 2095, 2096, 2097, 2098, 2099, 2100, 2101, 2102, 2103, 2104, 2105, 2106, 2107, 2108, 2109, 2110, 2111, 2112, 2113, 2114, 2115, 2116, 2117, 2118, 2119, 2120, 2121, 2122, 2123, 2124, 2125, 2126, 2127, 2128, 2129, 2130, 2131, 2132, 2133, 2134, 2135, 2136, 2137, 2138, 2139, 2140, 2141, 2142, 2143, 2144, 2145, 2146, 2147, 2148, 2149, 2150, 2151, 2152, 2153, 2154, 2155, 2156, 2157, 2158, 2159, 2160, 2161, 2162, 2163, 2164, 2165, 2166, 2167, 2168, 2169, 2170, 2171, 2172, 2173, 2174, 2175, 2176, 2177, 2178, 2179, 2180, 2181, 2182, 2183, 2184, 2185, 2186, 2187, 2188, 2189, 2190, 2191, 2192, 2193, 2194, 2195, 2196, 2197, 2198, 2199, 2200, 2201, 2202, 2203, 2204, 2205, 2206, 2207, 2208, 2209, 2210, 2211, 2212, 2213, 2214, 2215, 2216, 2217, 2218, 2219, 2220, 2221, 2222, 2223, 2224, 2225, 2226, 2227, 2228, 2229, 2230, 2231, 2232, 2233, 2234, 2235, 2236, 2237, 2238, 2239, 2240, 2241, 2242, 2243, 2244, 2245, 2246, 2247, 2248, 2249, 2250, 2251, 2252, 2253, 2254, 2255, 2256, 2257, 2258, 2259, 2260, 2261, 2262, 2263, 2264, 2265, 2266, 2267, 2268, 2269, 2270, 2271, 2272, 2273, 2274, 2275, 2276, 2277, 2278, 2279, 2280, 2281, 2282, 2283, 2284, 2285, 2286, 2287, 2288, 2289, 2290, 2291, 2292, 2293, 2294, 2295, 2296, 2297, 2298, 2299, 2300, 2301, 2302, 2303, 2304, 2305, 2306, 2307, 2308, 2309, 2310, 2311, 2312, 2313, 2314, 2315, 2316, 2317, 2318, 2319, 2320, 2321, 2322, 2323, 2324, 2325, 2326, 2327, 2328, 2329, 2330, 2331, 2332, 2333, 2334, 2335, 2336, 2337, 2338, 2339, 2340, 2341, 2342, 2343, 2344, 2345, 2346, 2347, 2348, 2349, 2350, 2351, 2352, 2353, 2354, 2355, 2356, 2357, 2358, 2359, 2360, 2361, 2362, 2363, 2364, 2365, 2366, 2367, 2368, 2369, 2370, 2371, 2372, 2373, 2374, 2375, 2376, 2377, 2378, 2379, 2380, 2381, 2382, 2383, 2384, 2385, 2386, 2387, 2388, 2389, 2390, 2391, 2392, 2393, 2394, 2395, 2396, 2397, 2398, 2399, 2400, 2401, 2402, 2403, 2404, 2405, 2406, 2407, 2408, 2409, 2410, 2411, 2412, 2413, 2414, 2415, 2416, 2417, 2418, 2419, 2420, 2421, 2422, 2423, 2424, 2425, 2426, 2427, 2428, 2429, 2430, 2431, 2432, 2433, 2434, 2435, 2436, 2437, 2438, 2439, 2440, 2441, 2442, 2443, 2444, 2445, 2446, 2447, 2448, 2449, 2450, 2451, 2452, 2453, 2454, 2455, 2456, 2457, 2458, 2459, 2460, 2461, 2462, 2463, 2464, 2465, 2466, 2467, 2468, 2469, 2470, 2471, 2472, 2473, 2474, 2475, 2476, 2477, 2478, 2479, 2480, 2481, 2482, 2483, 2484, 2485, 2486, 2487, 2488, 2489, 2490, 2491, 2492, 2493, 2494, 2495, 2496, 2497, 2498, 2499, 2500, 2501, 2502, 2503, 2504, 2505, 2506, 2507, 2508, 2509, 2510, 2511, 2512, 2513, 2514, 2515, 2516, 2517, 2518, 2519, 2520, 2521, 2522, 2523, 2524, 2525, 2526, 2527, 2528, 2529, 2530, 2531, 2532, 2533, 2534, 2535, 2536, 2537, 2538, 2539, 2540, 2541, 2542, 2543, 2544, 2545, 2546, 2547, 2548, 2549, 2550, 2551, 2552, 2553, 2554, 2555, 2556, 2557, 2558, 2559, 2560, 2561, 2562, 2563, 2564, 2565, 2566, 2567, 2568, 2569, 2570, 2571, 2572, 2573, 2574, 2575, 2576, 2577, 2578, 2579, 2580, 2581, 2582, 2583, 2584, 2585, 2586, 2587, 2588, 2589, 2590, 2591, 2592, 2593, 2594, 2595, 2596, 2597, 2598, 2599, 2600, 2601, 2602, 2603, 2604, 2605, 2606, 2607, 2608, 2609, 2610, 2611, 2612, 2613, 2614, 2615, 2616, 2617, 2618, 2619, 2620, 2621, 2622, 2623, 2624, 2625, 2626, 2627, 2628, 2629, 2630, 2631, 2632, 2633, 2634, 2635, 2636, 2637, 2638, 2639, 2640, 2641, 2642, 2643, 2644, 2645, 2646, 2647, 2648, 2649, 2650, 2651, 2652, 2653, 2654, 2655, 2656, 2657, 2658, 2659, 2660, 2661, 2662, 2663, 2664, 2665, 2666, 2667, 2668, 2669, 2670, 2671, 2672, 2673, 2674, 2675, 2676, 2677, 2678, 2679, 2680, 2681, 2682, 2683, 2684, 2685, 2686, 2687, 2688, 2689, 2690, 2691, 2692, 2693, 2694, 2695, 2696, 2697, 2698, 2699, 2700, 2701, 2702, 2703, 2704, 2705, 2706, 2707, 2708, 2709, 2710, 2711, 2712, 2713, 2714, 2715, 2716, 2717, 2718, 2719, 2720, 2721, 2722, 2723, 2724, 2725, 2726, 2727, 2728, 2729, 2730, 2731, 2732, 2733, 2734, 2735, 2736, 2737, 2738, 2739, 2740, 2741, 2742, 2743, 2744, 2745, 2746, 2747, 2748, 2749, 2750, 2751, 2752, 2753, 2754, 2755, 2756, 2757, 2758, 2759, 2760, 2761, 2762, 2763, 2764, 2765, 2766, 2767, 2768, 2769, 2770, 2771, 2772, 2773, 2774, 2775, 2776, 2777, 2778, 2779, 2780, 2781, 2782, 2783, 2784, 2785, 2786, 2787, 2788, 2789, 2790, 2791, 2792, 2793, 2794, 2795, 2796, 2797, 2798, 2799, 2800, 2801, 2802, 2803, 2804, 2805, 2806, 2807, 2808, 2809, 2810, 2811, 2812, 2813, 2814, 2815, 2816, 2817, 2818, 2819, 2820, 2821, 2822, 2823, 2824, 2825, 2826, 2827, 2828, 2829, 2830, 2831, 2832, 2833, 2834, 2835, 2836, 2837, 2838, 2839, 2840, 2841, 2842, 2843, 2844, 2845, 2846, 2847, 2848, 2849, 2850, 2851, 2852, 2853, 2854, 2855, 2856, 2857, 2858, 2859, 2860, 2861, 2862, 2863, 2864, 2865, 2866, 2867, 2868, 2869, 2870, 2871, 2872, 2873, 2874, 2875, 2876, 2877, 2878, 2879, 2880, 2881, 2882, 2883, 2884, 2885, 2886, 2887, 2888, 2889, 2890, 2891, 2892, 2893, 2894, 2895, 2896, 2897, 2898, 2899, 2900, 2901, 2902, 2903, 2904, 2905, 2906, 2907, 2908, 2909, 2910, 2911, 2912, 2913, 2914, 2915, 2916, 2917, 2918, 2919, 2920, 2921, 2922, 2923, 2924, 2925, 2926, 2927, 2928, 2929, 2930, 2931, 2932, 2933, 2934, 2935, 2936, 2937, 2938, 2939, 2940, 2941, 2942, 2943, 2944, 2945, 2946, 2947, 2948, 2949, 2950, 2951, 2952, 2953, 2954, 2955, 2956, 2957, 2958, 2959, 2960, 2961, 2962, 2963, 2964, 2965, 2966, 2967, 2968, 2969, 2970, 2971, 2972, 2973, 2974, 2975, 2976, 2977, 2978, 2979, 2980, 2981, 2982, 2983, 2984, 2985, 2986, 2987, 2988, 2989, 2990, 2991, 2992, 2993, 2994, 2995, 2996, 2997, 2998, 2999, 3000, 3001, 3002, 3003, 3004, 3005, 3006, 3007, 3008, 3009, 3010, 3011, 3012, 3013, 3014, 3015, 3016, 3017, 3018, 3019, 3020, 3021, 3022, 3023, 3024, 3025, 3026, 3027, 3028, 3029, 3030, 3031, 3032, 3033, 3034, 3035, 3036, 3037, 3038, 3039, 3040, 3041, 3042, 3043, 3044, 3045, 3046, 3047, 3048, 3049, 3050, 3051, 3052, 3053, 3054, 3055, 3056, 3057, 3058, 3059, 3060, 3061, 3062, 3063, 3064, 3065, 3066, 3067, 3068, 3069, 3070, 3071, 3072, 3073, 3074, 3075, 3076, 3077, 3078, 3079, 3080, 3081, 3082, 3083, 3084, 3085, 3086, 3087, 3088, 3089, 3090, 3091, 3092, 3093, 3094, 3095, 3096, 3097, 3098, 3099, 3100, 3101, 3102, 3103, 3104, 3105, 3106, 3107, 3108, 3109, 3110, 3111, 3112, 3113, 3114, 3115, 3116, 3117, 3118, 3119, 3120, 3121, 3122, 3123, 3124, 3125, 3126, 3127, 3128, 3129, 3130, 3131, 3132, 3133, 3134, 3135, 3136, 3137, 3138, 3139, 3140, 3141, 3142, 3143, 3144, 3145, 3146, 3147, 3148, 3149, 3150, 3151, 3152, 3153, 3154, 3155, 3156, 3157, 3158, 3159, 3160, 3161, 3162, 3163, 3164, 3165, 3166, 3167, 3168, 3169, 3170, 3171, 3172, 3173, 3174, 3175, 3176, 3177, 3178, 3179, 3180, 3181, 3182, 3183, 3184, 3185, 3186, 3187, 3188, 3189, 3190, 3191, 3192, 3193, 3194, 3195, 3196, 3197, 3198, 3199, 3200, 3201, 3202, 3203, 3204, 3205, 3206, 3207, 3208, 3209, 3210, 3211, 3212, 3213, 3214, 3215, 3216, 3217, 3218, 3219, 3220, 3221, 3222, 3223, 3224, 3225, 3226, 3227, 3228, 3229, 3230, 3231, 3232, 3233, 3234, 3235, 3236, 3237, 3238, 3239, 3240, 3241, 3242, 3243, 3244, 3245, 3246, 3247, 3248, 3249, 3250, 3251, 3252, 3253, 3254, 3255, 3256, 3257, 3258, 3259, 3260, 3261, 3262, 3263, 3264, 3265, 3266, 3267, 3268, 3269, 3270, 3271, 3272, 3273, 3274, 3275, 3276, 3277, 3278, 3279, 3280, 3281, 3282, 3283, 3284, 3285, 3286, 3287, 3288, 3289, 3290, 3291, 3292, 3293, 3294, 3295, 3296, 3297, 3298, 3299, 3300, 3301, 3302, 3303, 3304, 3305, 3306, 3307, 3308, 3309, 3310, 3311, 3312, 3313, 3314, 3315, 3316, 3317, 3318, 3319, 3320, 3321, 3322, 3323, 3324, 3325, 3326, 3327, 3328, 3329, 3330, 3331, 3332, 3333, 3334, 3335, 3336, 3337, 3338, 3339, 3340, 3341, 3342, 3343, 3344, 3345, 3346, 3347, 3348, 3349, 3350, 3351, 3352, 3353, 3354, 3355, 3356, 3357, 3358, 3359, 3360, 3361, 3362, 3363, 3364, 3365, 3366, 3367, 3368, 3369, 3370, 3371, 3372, 3373, 3374, 3375, 3376, 3377, 3378, 3379, 3380, 3381, 3382, 3383, 3384, 3385, 3386, 3387, 3388, 3389, 3390, 3391, 3392, 3393, 3394, 3395, 3396, 3397, 3398, 3399, 3400, 3401, 3402, 3403, 3404, 3405, 3406, 3407, 3408, 3409, 3410, 3411, 3412, 3413, 3414, 3415, 3416, 3417, 3418, 3419, 3420, 3421, 3422, 3423, 3424, 3425, 3426, 3427, 3428, 3429, 3430, 3431, 3432, 3433, 3434, 3435, 3436, 3437, 3438, 3439, 3440, 3441, 3442, 3443, 3444, 3445, 3446, 3447, 3448, 3449, 3450, 3451, 3452, 3453, 3454, 3455, 3456, 3457, 3458, 3459, 3460, 3461, 3462, 3463, 3464, 3465, 3466, 3467, 3468, 3469, 3470, 3471, 3472, 3473, 3474, 3475, 3476, 3477, 3478, 3479, 3480, 3481, 3482, 3483, 3484, 3485, 3486, 3487, 3488, 3489, 3490, 3491, 3492, 3493, 3494, 3495, 3496, 3497, 3498, 3499, 3500, 3501, 3502, 3503, 3504, 3505, 3506, 3507, 3508, 3509, 3510, 3511, 3512, 3513, 3514, 3515, 3516, 3517, 3518, 3519, 3520, 3521, 3522, 3523, 3524, 3525, 3526, 3527, 3528, 3529, 3530, 3531, 3532, 3533, 3534, 3535, 3536, 3537, 3538, 3539, 3540, 3541, 3542, 3543, 3544, 3545, 3546, 3547, 3548, 3549, 3550, 3551, 3552, 3553, 3554, 3555, 3556, 3557, 3558, 3559, 3560, 3561, 3562, 3563, 3564, 3565, 3566, 3567, 3568, 3569, 3570, 3571, 3572, 3573, 3574, 3575, 3576, 3577, 3578, 3579, 3580, 3581, 3582, 3583, 3584, 3585, 3586, 3587, 3588, 3589, 3590, 3591, 3592, 3593, 3594, 3595, 3596, 3597, 3598, 3599, 3600, 3601, 3602, 3603, 3604, 3605, 3606, 3607, 3608, 3609, 3610, 3611, 3612, 3613, 3614, 3615, 3616, 3617, 3618, 3619, 3620, 3621, 3622, 3623, 3624, 3625, 3626, 3627, 3628, 3629, 3630, 3631, 3632, 3633, 3634, 3635, 3636, 3637, 3638, 3639, 3640, 3641, 3642, 3643, 3644, 3645, 3646, 3647, 3648, 3649, 3650, 3651, 3652, 3653, 3654, 3655, 3656, 3657, 3658, 3659, 3660, 3661, 3662, 3663, 3664, 3665, 3666, 3667, 3668, 3669, 3670, 3671, 3672, 3673, 3674, 3675, 3676, 3677, 3678, 3679, 3680, 3681, 3682, 3683, 3684, 3685, 3686, 3687, 3688, 3689, 3690, 3691, 3692, 3693, 3694, 3695, 3696, 3697, 3698, 3699, 3700, 3701, 3702, 3703, 3704, 3705, 3706, 3707, 3708, 3709, 3710, 3711, 3712, 3713, 3714, 3715, 3716, 3717, 3718, 3719, 3720, 3721, 3722, 3723, 3724, 3725, 3726, 3727, 3728, 3729, 3730, 3731, 3732, 3733, 3734, 3735, 3736, 3737, 3738, 3739, 3740, 3741, 3742, 3743, 3744, 3745, 3746, 3747, 3748, 3749, 3750, 3751, 3752, 3753, 3754, 3755, 3756, 3757, 3758, 3759, 3760, 3761, 3762, 3763, 3764, 3765, 3766, 3767, 3768, 3769, 3770, 3771, 3772, 3773, 3774, 3775, 3776, 3777, 3778, 3779, 3780, 3781, 3782, 3783, 3784, 3785, 3786, 3787, 3788, 3789, 3790, 3791, 3792, 3793, 3794, 3795, 3796, 3797, 3798, 3799, 3800, 3801, 3802, 3803, 3804, 3805, 3806, 3807, 3808, 3809, 3810, 3811, 3812, 3813, 3814, 3815, 3816, 3817, 3818, 3819, 3820, 3821, 3822, 3823, 3824, 3825, 3826, 3827, 3828, 3829, 3830, 3831, 3832, 3833, 3834, 3835, 3836, 3837, 3838, 3839, 3840, 3841, 3842, 3843, 3844, 3845, 3

Project Design Drawing Notes

1. Drawings issued are for planning application purposes only.
2. Drawings not to be used for construction/contract conditions.
3. Copyright, all rights reserved. No part herewith may be copied or reproduced partially or wholly in any form whatsoever without the prior notice of the copyright owner McCarthy Keville O'Sullivan.
4. Do not scale off this drawing. Figured metric dimensions only should be taken off this drawing.
5. All contractors, whether main or sub-contractors, must visit the site and are responsible for taking and checking any and all dimensions and levels that relate to the works.
6. The use of or reliance upon this drawing shall be deemed to be acceptance of these conditions of use unless otherwise agreed in writing, such written agreement to be sought from and issued by the copyright holder to the use or reliance upon this drawing.
7. Layout plans show typical Turbine rotor diameter as per turbine drawing.
8. Final levels may vary depending on local ground conditions.
9. Exact location of cable/joint bay in the road corridor to be subject to ESB specifications and agreement with Westmeath County Council



Drawing Legend

- Planning Application Boundary
- Grid Connection Route
- Joint Bay
- Watercrossing

Ordnance Survey Ireland Licence No. CYAL50267517@Ordnance Survey Ireland/Government of Ireland

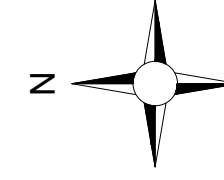

**Site Layout Plan
Sheet 17 of 24**

PROJECT TITLE:
Coolo Wind Farm FI, Co. Westmeath

DRAWING BY:	Joseph O'Brien	CHECKED BY:	Meabhann Crowe
PROJECT No:	200445g	DRAWING No:	200445g - 30 FI
SCALE:	1:2,500 @ A1	DATE:	27.10.2022

OS SHEET No: 1:25,000 (1:50,000) 2004, 2002, 2001, 2000, 1999, 1998, 1997, 1996, 1995, 1994, 1993, 1992, 1991, 1990, 1989, 1988, 1987, 1986, 1985, 1984, 1983, 1982, 1981, 1980, 1979, 1978, 1977, 1976, 1975, 1974, 1973, 1972, 1971, 1970, 1969, 1968, 1967, 1966, 1965, 1964, 1963, 1962, 1961, 1960, 1959, 1958, 1957, 1956, 1955, 1954, 1953, 1952, 1951, 1950, 1949, 1948, 1947, 1946, 1945, 1944, 1943, 1942, 1941, 1940, 1939, 1938, 1937, 1936, 1935, 1934, 1933, 1932, 1931, 1930, 1929, 1928, 1927, 1926, 1925, 1924, 1923, 1922, 1921, 1920, 1919, 1918, 1917, 1916, 1915, 1914, 1913, 1912, 1911, 1910, 1909, 1908, 1907, 1906, 1905, 1904, 1903, 1902, 1901, 1900, 1899, 1898, 1897, 1896, 1895, 1894, 1893, 1892, 1891, 1890, 1889, 1888, 1887, 1886, 1885, 1884, 1883, 1882, 1881, 1880, 1879, 1878, 1877, 1876, 1875, 1874, 1873, 1872, 1871, 1870, 1869, 1868, 1867, 1866, 1865, 1864, 1863, 1862, 1861, 1860, 1859, 1858, 1857, 1856, 1855, 1854, 1853, 1852, 1851, 1850, 1849, 1848, 1847, 1846, 1845, 1844, 1843, 1842, 1841, 1840, 1839, 1838, 1837, 1836, 1835, 1834, 1833, 1832, 1831, 1830, 1829, 1828, 1827, 1826, 1825, 1824, 1823, 1822, 1821, 1820, 1819, 1818, 1817, 1816, 1815, 1814, 1813, 1812, 1811, 1810, 1809, 1808, 1807, 1806, 1805, 1804, 1803, 1802, 1801, 1800, 1799, 1798, 1797, 1796, 1795, 1794, 1793, 1792, 1791, 1790, 1789, 1788, 1787, 1786, 1785, 1784, 1783, 1782, 1781, 1780, 1779, 1778, 1777, 1776, 1775, 1774, 1773, 1772, 1771, 1770, 1769, 1768, 1767, 1766, 1765, 1764, 1763, 1762, 1761, 1760, 1759, 1758, 1757, 1756, 1755, 1754, 1753, 1752, 1751, 1750, 1749, 1748, 1747, 1746, 1745, 1744, 1743, 1742, 1741, 1740, 1739, 1738, 1737, 1736, 1735, 1734, 1733, 1732, 1731, 1730, 1729, 1728, 1727, 1726, 1725, 1724, 1723, 1722, 1721, 1720, 1719, 1718, 1717, 1716, 1715, 1714, 1713, 1712, 1711, 1710, 1709, 1708, 1707, 1706, 1705, 1704, 1703, 1702, 1701, 1700, 1699, 1698, 1697, 1696, 1695, 1694, 1693, 1692, 1691, 1690, 1689, 1688, 1687, 1686, 1685, 1684, 1683, 1682, 1681, 1680, 1679, 1678, 1677, 1676, 1675, 1674, 1673, 1672, 1671, 1670, 1669, 1668, 1667, 1666, 1665, 1664, 1663, 1662, 1661, 1660, 1659, 1658, 1657, 1656, 1655, 1654, 1653, 1652, 1651, 1650, 1649, 1648, 1647, 1646, 1645, 1644, 1643, 1642, 1641, 1640, 1639, 1638, 1637, 1636, 1635, 1634, 1633, 1632, 1631, 1630, 1629, 1628, 1627, 1626, 1625, 1624, 1623, 1622, 1621, 1620, 1619, 1618, 1617, 1616, 1615, 1614, 1613, 1612, 1611, 1610, 1609, 1608, 1607, 1606, 1605, 1604, 1603, 1602, 1601, 1600, 1599, 1598, 1597, 1596, 1595, 1594, 1593, 1592, 1591, 1590, 1589, 1588, 1587, 1586, 1585, 1584, 1583, 1582, 1581, 1580, 1579, 1578, 1577, 1576, 1575, 1574, 1573, 1572, 1571, 1570, 1569, 1568, 1567, 1566, 1565, 1564, 1563, 1562, 1561, 1560, 1559, 1558, 1557, 1556, 1555, 1554, 1553, 1552, 1551, 1550, 1549, 1548, 1547, 1546, 1545, 1544, 1543, 1542, 1541, 1540, 1539, 1538, 1537, 1536, 1535, 1534, 1533, 1532, 1531, 1530, 1529, 1528, 1527, 1526, 1525, 1524, 1523, 1522, 1521, 1520, 1519, 1518, 1517, 1516, 1515, 1514, 1513, 1512, 1511, 1510, 1509, 1508, 1507, 1506, 1505, 1504, 1503, 1502, 1501, 1500, 1499, 1498, 1497, 1496, 1495, 1494, 1493, 1492, 1491, 1490, 1489, 1488, 1487, 1486, 1485, 1484, 1483, 1482, 1481, 1480, 1479, 1478, 1477, 1476, 1475, 1474, 1473, 1472, 1471, 1470, 1469, 1468, 1467, 1466, 1465, 1464, 1463, 1462, 1461, 1460, 1459, 1458, 1457, 1456, 1455, 1454, 1453, 1452, 1451, 1450, 1449, 1448, 1447, 1446, 1445, 1444, 1443, 1442, 1441, 1440, 1439, 1438, 1437, 1436, 1435, 1434, 1433, 1432, 1431, 1430, 1429, 1428, 1427, 1426, 1425, 1424, 1423, 1422, 1421, 1420, 1419, 1418, 1417, 1416, 1415, 1414, 1413, 1412, 1411, 1410, 1409, 1408, 1407, 1406, 1405, 1404, 1403, 1402, 1401, 1400, 1399, 1398, 1397, 1396, 1395, 1394, 1393, 1392, 1391, 1390, 1389, 1388, 1387, 1386, 1385, 1384, 1383, 1382, 1381, 1380, 1379, 1378, 1377, 1376, 1375, 1374, 1373, 1372, 1371, 1370, 1369, 1368, 1367, 1366, 1365, 1364, 1363, 1362, 1361, 1360, 1359, 1358, 1357, 1356, 1355, 1354, 1353, 1352, 1351, 1350, 1349, 1348, 1347, 1346, 1345, 1344, 1343, 1342, 1341, 1340, 1339, 1338, 1337, 1336, 1335, 1334, 1333, 1332, 1331, 1330, 1329, 1328, 1327, 1326, 1325, 1324, 1323, 1322, 1321, 1320, 1319, 1318, 1317, 1316, 1315, 1314, 1313, 1312, 1311, 1310, 1309, 1308, 1307, 1306, 1305, 1304, 1303, 1302, 1301, 1300, 1299, 1298, 1297, 1296, 1295, 1294, 1293, 1292, 1291, 1290, 1289, 1288, 1287, 1286, 1285, 1284, 1283, 1282, 1281, 1280, 1279, 1278, 1277, 1276, 1275, 1274, 1273, 1272, 1271, 1270, 1269, 1268, 1267, 1266, 1265, 1264, 1263, 1262, 1261, 1260, 1259, 1258, 1257, 1256, 1255, 1254, 1253, 1252, 1251, 1250, 1249, 1248, 1247, 1246, 1245, 1244, 1243, 1242, 1241, 1240, 1239, 1238, 1237, 1236, 1235, 1234, 1233, 1232, 1231, 1230, 1229, 1228, 1227, 1226, 1225, 1224, 1223, 1222, 1221, 1220, 1219, 1218, 1217, 1216, 1215, 1214, 1213, 1212, 1211, 1210, 1209, 1208, 1207, 1206, 1205, 1204, 1203, 1202, 1201, 1200, 1199, 1198, 1197, 1196, 1195, 1194, 1193, 1192, 1191, 1190, 1189, 1188, 1187, 1186, 1185, 1184, 1183, 1182, 1181, 1180, 1179, 1178, 1177, 1176, 1175, 1174, 1173, 1172, 1171, 1170, 1169, 1168, 1167, 1166, 1165, 1164, 1163, 1162, 1161, 1160, 1159, 1158, 1157, 1156, 1155, 1154, 1153, 1152, 1151, 1150, 1149, 1148, 1147, 1146, 1145, 1144, 1143, 1142, 1141, 1140, 1139, 1138, 1137, 1136, 1135, 1134, 1133, 1132, 1131, 1130, 1129, 1128, 1127, 1126, 1125, 1124, 1123, 1122, 1121, 1120, 1119, 1118, 1117, 1116, 1115, 1114, 1113, 1112, 1111, 1110, 1109, 1108, 1107, 1106, 1105, 1104, 1103, 1102, 1101, 1100, 1099, 1098, 1097, 1096, 1095, 1094, 1093, 1092, 1091, 1090, 1089, 1088, 1087, 1086, 1085, 1084, 1083, 1082, 1081, 1080, 1079, 1078, 1077, 1076, 1075, 1074, 1073, 1072, 1071, 1070, 1069, 1068, 1067, 1066, 1065, 1064, 1063, 1062, 1061, 1060, 1059, 1058, 1057, 1056, 1055, 1054, 1053, 1052, 1051, 1050, 1049, 1048, 1047, 1046, 1045, 1044, 1043, 1042, 1041, 1040, 1039, 1038, 1037, 1036, 1035, 1034, 1033, 1032, 1031, 1030, 1029, 1028, 1027, 1026, 1025, 1024, 1023, 1022, 1021, 1020, 1019, 1018, 1017, 1016, 1015, 1014, 1013, 1012, 1011, 1010, 1009, 1008, 1007, 1006, 1005, 1004, 1003, 1002, 1001, 1000, 999, 998, 997, 996, 995, 994, 993, 992, 991, 990, 989, 988, 987, 986, 985, 984, 983, 982, 981, 980, 979, 978, 977, 976, 975, 974, 973, 972, 971, 970, 969, 968, 967, 966, 965, 964, 963, 962, 961, 960, 959, 958, 957, 956, 955, 954, 953, 952, 951, 950, 949, 948, 947, 946, 945, 944, 943, 942, 941, 940, 939, 938, 937, 936, 935, 934, 933, 932, 931, 930, 929, 928, 927, 926, 925, 924, 923, 922, 921, 920, 919, 918, 917, 916, 915, 914, 913, 912, 911, 910, 909, 908, 907, 906, 905, 904, 903, 902, 901, 900, 899, 898, 897, 896, 895, 894, 893, 892, 891, 890, 889, 888, 887, 886, 885, 884, 883, 882, 881, 880, 879, 878, 877, 876, 875, 874, 873, 872, 871, 870, 869, 868, 867, 866, 865, 864, 863, 862, 861, 860, 859, 858, 857, 856, 855, 854, 853, 852, 851, 850, 849, 848, 847, 846, 845, 844, 843, 842, 841, 840, 839, 838, 837, 836, 835, 834, 833, 832, 831, 830, 829, 828, 827, 826, 825, 824, 823, 822, 821, 820, 819, 818, 817, 816, 815, 814, 813, 812, 811, 810, 809, 808, 807, 806, 805, 804, 803, 802, 801, 800, 799, 798, 797, 796, 795, 794, 793, 792, 791, 790, 789, 788, 787, 786, 785, 784, 783, 782, 781, 780, 779, 778, 777, 776, 775, 774, 773, 772, 771, 770, 769, 768, 767, 766, 765, 764, 763, 762, 761, 760, 759, 758, 757, 756, 755, 754, 753, 752, 751, 750, 749, 748, 747, 746, 745, 744, 743, 742, 741, 740, 739, 738, 737, 736, 735, 734, 733, 732, 731, 730, 729, 728, 727, 726, 725, 724, 723, 722, 721, 720, 719, 718, 717, 716, 715, 714, 713, 712, 711, 710, 709, 708, 707, 706, 705, 704, 703, 702, 701, 700, 699, 698, 697, 696, 695, 694, 693, 692, 691, 690, 689, 688, 687, 686, 685, 684, 683, 682, 681, 680, 679, 678, 677, 676, 675, 674, 673, 672, 671, 670, 669, 668, 667, 666, 665, 664, 663, 662, 661, 660, 659, 658, 657, 656, 655, 654, 653, 652, 651, 650, 649, 648, 647, 646, 645, 644, 643, 642, 641, 640, 639, 638, 637, 636, 635, 634, 633, 632, 631, 630, 629, 628, 627, 626, 625, 624, 623, 622, 621, 620, 619, 618, 617, 616, 615, 614, 613, 612, 611, 610, 609, 608, 607, 606, 605, 604, 603, 602, 601, 600, 599, 598, 597, 596, 595, 594, 593, 592, 591, 590, 589, 588, 587, 586, 585, 584, 583, 582, 581, 580, 579, 578, 577, 576, 575, 574, 573, 572, 571, 570, 569, 568, 567, 566, 565, 564, 563, 562, 561, 560, 559, 558, 557, 556, 555, 554, 553, 552, 551, 550, 549, 548, 547, 546, 545, 544, 543, 542, 541, 540, 539, 538, 537, 536, 535, 534, 533, 532, 531, 530, 529, 528, 527, 526, 525, 524, 523, 522, 521, 520, 519, 518, 517, 516, 515, 514, 513, 512, 511, 510, 509, 508, 507, 506, 505, 504, 503, 502, 501, 500, 499, 498, 497, 496, 495, 494, 493, 492, 491, 490, 489, 488, 487, 486, 485, 484, 483, 482, 481, 480, 479, 478, 477, 476, 475, 474, 473, 472, 471, 470, 469, 468, 467, 466, 465, 464, 463, 462, 461, 460, 459, 458, 457, 456, 455, 454, 453, 452, 451, 450, 449, 448, 447, 446, 445, 444, 443, 442, 441, 440, 439, 438, 437, 436, 435, 434, 433, 432, 431, 430, 429, 428, 427, 426, 425, 424, 423, 422, 421, 420, 419, 418, 417, 416, 415, 414, 413, 412, 411, 410, 409, 408, 407, 406, 405, 404, 403, 402, 401, 400, 399, 398, 397, 396, 395, 394, 393, 392, 391, 390, 389, 388, 387, 386, 385, 384, 383, 382, 381, 380, 379, 378, 377, 376, 375, 374, 373, 372, 371, 370, 369, 368, 367, 366, 365, 364, 363, 362, 361, 360, 359, 358, 357, 356, 355, 354, 353, 352, 351, 350, 349, 348, 347, 346, 345, 344, 343, 342, 341, 340, 339, 338, 337, 336, 335, 334, 333, 332, 331, 330, 329, 328, 327, 326, 325, 324, 323, 322, 321, 320, 319, 318, 317, 316, 315, 314, 313, 312, 311, 310, 309, 308, 307, 306, 305, 304, 303, 302, 301, 300, 299, 298, 297, 296, 295, 294, 293, 292, 291, 290, 289, 288, 287, 286, 285, 284, 283, 282, 281, 280, 279, 278, 277, 276, 275, 274, 273, 272, 271, 270, 269, 268, 267, 266, 265, 264, 263, 262, 261, 260, 259, 258, 257, 256, 255, 254, 253, 252, 251, 250, 249, 248, 247, 246, 245, 244, 243, 242, 241, 240, 239, 238, 237, 236, 235, 234, 233, 232, 231, 230, 229, 228, 227, 226, 225, 224, 223, 222, 221, 220, 219, 218, 217, 216, 215, 214, 213, 212, 211, 210, 209, 208, 207, 206, 205, 204, 203, 202, 201, 200, 199, 198, 197, 196, 195, 194, 193, 192, 191, 190, 189, 188, 187, 186, 185, 184, 183, 182, 181, 180, 179, 178, 177, 176, 175, 174, 173, 172, 171, 170, 169, 168, 167, 166, 165, 164, 163, 162, 161, 160, 159, 158, 157, 156, 155, 154, 153, 152, 151, 150, 149, 148, 147, 146, 145, 144, 143, 142, 141, 140, 139, 138, 137, 136, 135, 134, 133, 132, 131, 130, 129, 128, 127, 126, 125, 124, 123, 122, 121, 120, 119, 118, 117, 116, 115, 114, 113, 112, 111, 110, 109, 108, 107, 106, 105, 104, 103, 102, 101, 100, 99, 98, 97, 96, 95, 94, 93, 92, 91, 90, 89, 88, 87, 86, 85, 84, 83, 82, 81, 80, 79, 78, 77, 76, 75, 74, 73, 72, 71, 70, 69, 68, 67, 66, 65, 64, 63, 62, 61, 60, 59, 58, 57, 56, 55, 54, 53, 52, 51, 50, 49, 48, 47, 46, 45, 44, 43, 42, 41, 40, 39, 38, 37, 36, 35, 34, 33, 32, 31, 30, 29, 28, 27, 26, 25, 24, 23, 22, 21, 20, 19, 18, 17, 16, 15, 14, 13, 12, 11, 10, 9, 8, 7, 6, 5, 4, 3, 2, 1, 0, 99, 98, 97, 96, 95, 94, 93, 92, 91, 90, 89, 88, 87, 86, 85, 84, 83, 82, 81, 80, 79, 78, 77, 76, 75, 74, 73, 72, 71, 70, 69, 68, 67, 66, 65, 64, 63, 62, 61, 60, 59, 58, 57, 56, 55, 54, 53, 52, 51, 50, 49, 48, 47, 46, 45, 44, 43, 42, 41, 40, 39, 38, 37, 36, 35, 34, 33, 32, 31, 30, 29, 28, 27, 26, 25, 24, 23, 22, 21, 20, 19, 18, 17, 16, 15,

Project Design Drawing Notes

1. Drawings issued are for planning application purposes only.
2. Drawings not to be used for construction/contract conditions.
3. Copyright, all rights reserved. No part herewith may be copied or reproduced partially or wholly in any form whatsoever without the prior notice of the copyright owner McCarthy Keville O'Sullivan.
4. Do not scale off this drawing. Figured metric dimensions only should be taken off this drawing.
5. All contractors, whether main or sub-contractors, must visit the site and are responsible for taking and checking any and all dimensions and levels that relate to the works.
6. The use of or reliance upon this drawing shall be deemed to be acceptance of these conditions of use unless otherwise agreed in writing, such written agreement to be sought from and issued by the copyright holder to the use or reliance upon this drawing.
7. Layout plans show typical Turbine rotor diameter as per turbine drawing.
8. Final levels may vary depending on local ground conditions.
9. Exact location of cable/joint bay in the road corridor to be subject to ESB specifications and agreement with Westmeath County Council

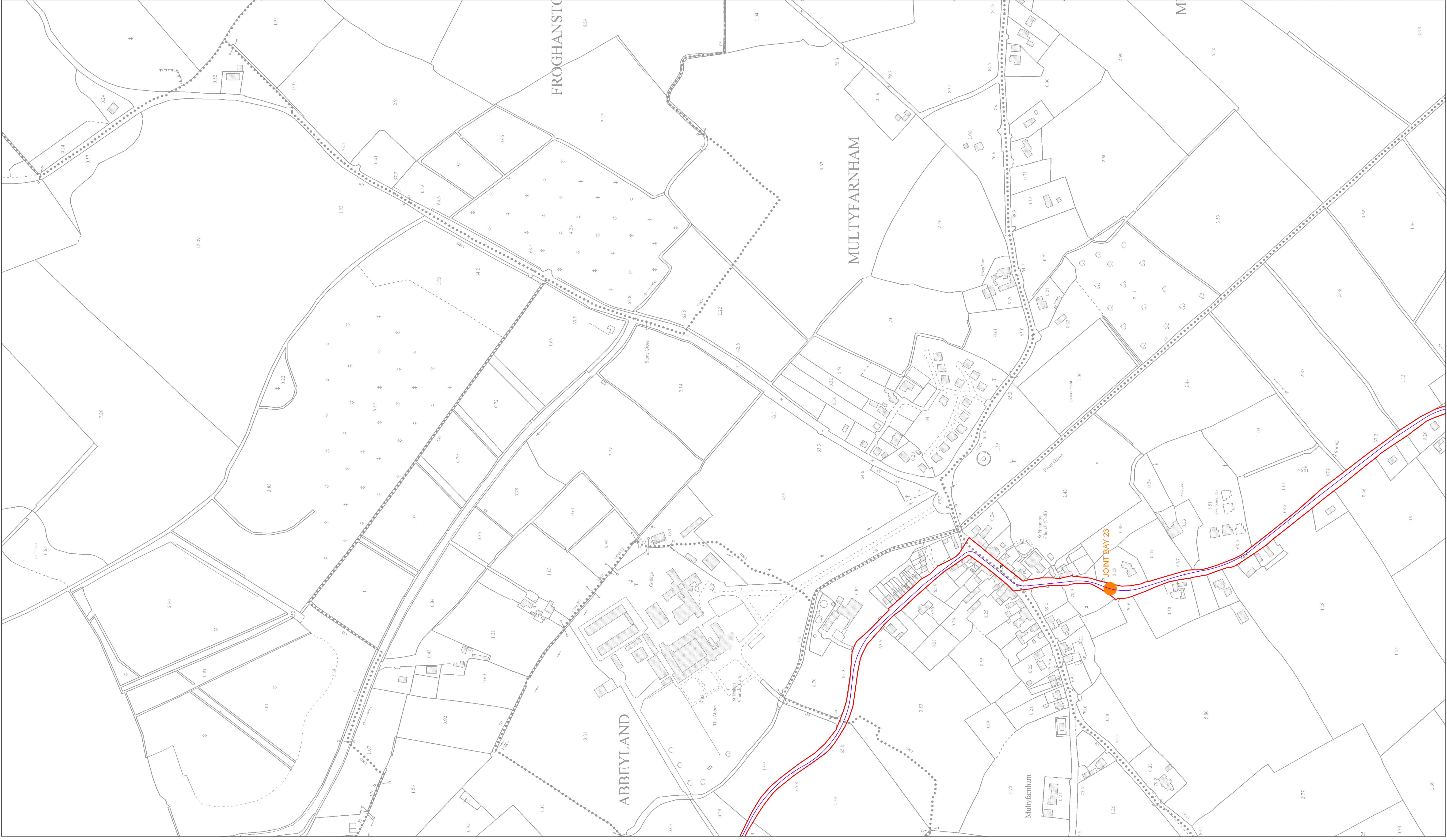

Drawing Legend

- Planning Application Boundary
- Grid Connection Route
- X Spot Height
- Joint Bay

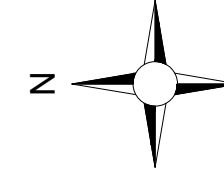

Ordnance Survey Ireland Licence No. CYAL50267517@Ordnance Survey Ireland/Government of Ireland

**Site Layout Plan
Sheet 19 of 24**

DRAWING TITLE

PROJECT TITLE	Cooile Wind Farm FI, Co. Westmeath
DRAWING BY	Joseph O'Brien
CHECKED BY	Meabhann Crowe
PROJECT No.	200445g - 32 FI
SCALE	1:2,500 @ A1
DATE	27.10.2022

OS SHEET No.: 2004, 2005, 2006, 2007, 2008, 2009, 2010, 2011, 2012, 2013, 2014, 2015, 2016, 2017, 2018, 2019, 2020, 2021, 2022, 2023, 2024, 2025, 2026, 2027, 2028, 2029, 2030, 2031, 2032, 2033, 2034, 2035, 2036, 2037, 2038, 2039, 2040, 2041, 2042, 2043, 2044, 2045, 2046, 2047, 2048, 2049, 2050, 2051, 2052, 2053, 2054, 2055, 2056, 2057, 2058, 2059, 2060, 2061, 2062, 2063, 2064, 2065, 2066, 2067, 2068, 2069, 2070, 2071, 2072, 2073, 2074, 2075, 2076, 2077, 2078, 2079, 2080, 2081, 2082, 2083, 2084, 2085, 2086, 2087, 2088, 2089, 2090, 2091, 2092, 2093, 2094, 2095, 2096, 2097, 2098, 2099, 2100, 2101, 2102, 2103, 2104, 2105, 2106, 2107, 2108, 2109, 2110, 2111, 2112, 2113, 2114, 2115, 2116, 2117, 2118, 2119, 2120, 2121, 2122, 2123, 2124, 2125, 2126, 2127, 2128, 2129, 2130, 2131, 2132, 2133, 2134, 2135, 2136, 2137, 2138, 2139, 2140, 2141, 2142, 2143, 2144, 2145, 2146, 2147, 2148, 2149, 2150, 2151, 2152, 2153, 2154, 2155, 2156, 2157, 2158, 2159, 2160, 2161, 2162, 2163, 2164, 2165, 2166, 2167, 2168, 2169, 2170, 2171, 2172, 2173, 2174, 2175, 2176, 2177, 2178, 2179, 2180, 2181, 2182, 2183, 2184, 2185, 2186, 2187, 2188, 2189, 2190, 2191, 2192, 2193, 2194, 2195, 2196, 2197, 2198, 2199, 2200, 2201, 2202, 2203, 2204, 2205, 2206, 2207, 2208, 2209, 2210, 2211, 2212, 2213, 2214, 2215, 2216, 2217, 2218, 2219, 2220, 2221, 2222, 2223, 2224, 2225, 2226, 2227, 2228, 2229, 2230, 2231, 2232, 2233, 2234, 2235, 2236, 2237, 2238, 2239, 2240, 2241, 2242, 2243, 2244, 2245, 2246, 2247, 2248, 2249, 2250, 2251, 2252, 2253, 2254, 2255, 2256, 2257, 2258, 2259, 2260, 2261, 2262, 2263, 2264, 2265, 2266, 2267, 2268, 2269, 2270, 2271, 2272, 2273, 2274, 2275, 2276, 2277, 2278, 2279, 2280, 2281, 2282, 2283, 2284, 2285, 2286, 2287, 2288, 2289, 2290, 2291, 2292, 2293, 2294, 2295, 2296, 2297, 2298, 2299, 2300, 2301, 2302, 2303, 2304, 2305, 2306, 2307, 2308, 2309, 2310, 2311, 2312, 2313, 2314, 2315, 2316, 2317, 2318, 2319, 2320, 2321, 2322, 2323, 2324, 2325, 2326, 2327, 2328, 2329, 2330, 2331, 2332, 2333, 2334, 2335, 2336, 2337, 2338, 2339, 2340, 2341, 2342, 2343, 2344, 2345, 2346, 2347, 2348, 2349, 2350, 2351, 2352, 2353, 2354, 2355, 2356, 2357, 2358, 2359, 2360, 2361, 2362, 2363, 2364, 2365, 2366, 2367, 2368, 2369, 2370, 2371, 2372, 2373, 2374, 2375, 2376, 2377, 2378, 2379, 2380, 2381, 2382, 2383, 2384, 2385, 2386, 2387, 2388, 2389, 2390, 2391, 2392, 2393, 2394, 2395, 2396, 2397, 2398, 2399, 2400, 2401, 2402, 2403, 2404, 2405, 2406, 2407, 2408, 2409, 2410, 2411, 2412, 2413, 2414, 2415, 2416, 2417, 2418, 2419, 2420, 2421, 2422, 2423, 2424, 2425, 2426, 2427, 2428, 2429, 2430, 2431, 2432, 2433, 2434, 2435, 2436, 2437, 2438, 2439, 2440, 2441, 2442, 2443, 2444, 2445, 2446, 2447, 2448, 2449, 2450, 2451, 2452, 2453, 2454, 2455, 2456, 2457, 2458, 2459, 2460, 2461, 2462, 2463, 2464, 2465, 2466, 2467, 2468, 2469, 2470, 2471, 2472, 2473, 2474, 2475, 2476, 2477, 2478, 2479, 2480, 2481, 2482, 2483, 2484, 2485, 2486, 2487, 2488, 2489, 2490, 2491, 2492, 2493, 2494, 2495, 2496, 2497, 2498, 2499, 2500, 2501, 2502, 2503, 2504, 2505, 2506, 2507, 2508, 2509, 2510, 2511, 2512, 2513, 2514, 2515, 2516, 2517, 2518, 2519, 2520, 2521, 2522, 2523, 2524, 2525, 2526, 2527, 2528, 2529, 2530, 2531, 2532, 2533, 2534, 2535, 2536, 2537, 2538, 2539, 2540, 2541, 2542, 2543, 2544, 2545, 2546, 2547, 2548, 2549, 2550, 2551, 2552, 2553, 2554, 2555, 2556, 2557, 2558, 2559, 2560, 2561, 2562, 2563, 2564, 2565, 2566, 2567, 2568, 2569, 2570, 2571, 2572, 2573, 2574, 2575, 2576, 2577, 2578, 2579, 2580, 2581, 2582, 2583, 2584, 2585, 2586, 2587, 2588, 2589, 2590, 2591, 2592, 2593, 2594, 2595, 2596, 2597, 2598, 2599, 2600, 2601, 2602, 2603, 2604, 2605, 2606, 2607, 2608, 2609, 2610, 2611, 2612, 2613, 2614, 2615, 2616, 2617, 2618, 2619, 2620, 2621, 2622, 2623, 2624, 2625, 2626, 2627, 2628, 2629, 2630, 2631, 2632, 2633, 2634, 2635, 2636, 2637, 2638, 2639, 2640, 2641, 2642, 2643, 2644, 2645, 2646, 2647, 2648, 2649, 2650, 2651, 2652, 2653, 2654, 2655, 2656, 2657, 2658, 2659, 2660, 2661, 2662, 2663, 2664, 2665, 2666, 2667, 2668, 2669, 2670, 2671, 2672, 2673, 2674, 2675, 2676, 2677, 2678, 2679, 2680, 2681, 2682, 2683, 2684, 2685, 2686, 2687, 2688, 2689, 2690, 2691, 2692, 2693, 2694, 2695, 2696, 2697, 2698, 2699, 2700, 2701, 2702, 2703, 2704, 2705, 2706, 2707, 2708, 2709, 2710, 2711, 2712, 2713, 2714, 2715, 2716, 2717, 2718, 2719, 2720, 2721, 2722, 2723, 2724, 2725, 2726, 2727, 2728, 2729, 2730, 2731, 2732, 2733, 2734, 2735, 2736, 2737, 2738, 2739, 2740, 2741, 2742, 2743, 2744, 2745, 2746, 2747, 2748, 2749, 2750, 2751, 2752, 2753, 2754, 2755, 2756, 2757, 2758, 2759, 2760, 2761, 2762, 2763, 2764, 2765, 2766, 2767, 2768, 2769, 2770, 2771, 2772, 2773, 2774, 2775, 2776, 2777, 2778, 2779, 2780, 2781, 2782, 2783, 2784, 2785, 2786, 2787, 2788, 2789, 2790, 2791, 2792, 2793, 2794, 2795, 2796, 2797, 2798, 2799, 2800, 2801, 2802, 2803, 2804, 2805, 2806, 2807, 2808, 2809, 2810, 2811, 2812, 2813, 2814, 2815, 2816, 2817, 2818, 2819, 2820, 2821, 2822, 2823, 2824, 2825, 2826, 2827, 2828, 2829, 2830, 2831, 2832, 2833, 2834, 2835, 2836, 2837, 2838, 2839, 2840, 2841, 2842, 2843, 2844, 2845, 2846, 2847, 2848, 2849, 2850, 2851, 2852, 2853, 2854, 2855, 2856, 2857, 2858, 2859, 2860, 2861, 2862, 2863, 2864, 2865, 2866, 2867, 2868, 2869, 2870, 2871, 2872, 2873, 2874, 2875, 2876, 2877, 2878, 2879, 2880, 2881, 2882, 2883, 2884, 2885, 2886, 2887, 2888, 2889, 2890, 2891, 2892, 2893, 2894, 2895, 2896, 2897, 2898, 2899, 2900, 2901, 2902, 2903, 2904, 2905, 2906, 2907, 2908, 2909, 2910, 2911, 2912, 2913, 2914, 2915, 2916, 2917, 2918, 2919, 2920, 2921, 2922, 2923, 2924, 2925, 2926, 2927, 2928, 2929, 2930, 2931, 2932, 2933, 2934, 2935, 2936, 2937, 2938, 2939, 2940, 2941, 2942, 2943, 2944, 2945, 2946, 2947, 2948, 2949, 2950, 2951, 2952, 2953, 2954, 2955, 2956, 2957, 2958, 2959, 2960, 2961, 2962, 2963, 2964, 2965, 2966, 2967, 2968, 2969, 2970, 2971, 2972, 2973, 2974, 2975, 2976, 2977, 2978, 2979, 2980, 2981, 2982, 2983, 2984, 2985, 2986, 2987, 2988, 2989, 2990, 2991, 2992, 2993, 2994, 2995, 2996, 2997, 2998, 2999, 3000, 3001, 3002, 3003, 3004, 3005, 3006, 3007, 3008, 3009, 3010, 3011, 3012, 3013, 3014, 3015, 3016, 3017, 3018, 3019, 3020, 3021, 3022, 3023, 3024, 3025, 3026, 3027, 3028, 3029, 3030, 3031, 3032, 3033, 3034, 3035, 3036, 3037, 3038, 3039, 3040, 3041, 3042, 3043, 3044, 3045, 3046, 3047, 3048, 3049, 3050, 3051, 3052, 3053, 3054, 3055, 3056, 3057, 3058, 3059, 3060, 3061, 3062, 3063, 3064, 3065, 3066, 3067, 3068, 3069, 3070, 3071, 3072, 3073, 3074, 3075, 3076, 3077, 3078, 3079, 3080, 3081, 3082, 3083, 3084, 3085, 3086, 3087, 3088, 3089, 3090, 3091, 3092, 3093, 3094, 3095, 3096, 3097, 3098, 3099, 3100, 3101, 3102, 3103, 3104, 3105, 3106, 3107, 3108, 3109, 3110, 3111, 3112, 3113, 3114, 3115, 3116, 3117, 3118, 3119, 3120, 3121, 3122, 3123, 3124, 3125, 3126, 3127, 3128, 3129, 3130, 3131, 3132, 3133, 3134, 3135, 3136, 3137, 3138, 3139, 3140, 3141, 3142, 3143, 3144, 3145, 3146, 3147, 3148, 3149, 3150, 3151, 3152, 3153, 3154, 3155, 3156, 3157, 3158, 3159, 3160, 3161, 3162, 3163, 3164, 3165, 3166, 3167, 3168, 3169, 3170, 3171, 3172, 3173, 3174, 3175, 3176, 3177, 3178, 3179, 3180, 3181, 3182, 3183, 3184, 3185, 3186, 3187, 3188, 3189, 3190, 3191, 3192, 3193, 3194, 3195, 3196, 3197, 3198, 3199, 3200, 3201, 3202, 3203, 3204, 3205, 3206, 3207, 3208, 3209, 3210, 3211, 3212, 3213, 3214, 3215, 3216, 3217, 3218, 3219, 3220, 3221, 3222, 3223, 3224, 3225, 3226, 3227, 3228, 3229, 3230, 3231, 3232, 3233, 3234, 3235, 3236, 3237, 3238, 3239, 3240, 3241, 3242, 3243, 3244, 3245, 3246, 3247, 3248, 3249, 3250, 3251, 3252, 3253, 3254, 3255, 3256, 3257, 3258, 3259, 3260, 3261, 3262, 3263, 3264, 3265, 3266, 3267, 3268, 3269, 3270, 3271, 3272, 3273, 3274, 3275, 3276, 3277, 3278, 3279, 3280, 3281, 3282, 3283, 3284, 3285, 3286, 3287, 3288, 3289, 3290, 3291, 3292, 3293, 3294, 3295, 3296, 3297, 3298, 3299, 3300, 3301, 3302, 3303, 3304, 3305, 3306, 3307, 3308, 3309, 3310, 3311, 3312, 3313, 3314, 3315, 3316, 3317, 3318, 3319, 3320, 3321, 3322, 3323, 3324, 3325, 3326, 3327, 3328, 3329, 3330, 3331, 3332, 3333, 3334, 3335, 3336, 3337, 3338, 3339, 3340, 3341, 3342, 3343, 3344, 3345, 3346, 3347, 3348, 3349, 3350, 3351, 3352, 3353, 3354, 3355, 3356, 3357, 3358, 3359, 3360, 3361, 3362, 3363, 3364, 3365, 3366, 3367, 3368, 3369, 3370, 3371, 3372, 3373, 3374, 3375, 3376, 3377, 3378, 3379, 3380, 3381, 3382, 3383, 3384, 3385, 3386, 3387, 3388, 3389, 3390, 3391, 3392, 3393, 3394, 3395, 3396, 3397, 3398, 3399, 3400, 3401, 3402, 3403, 3404, 3405, 3406, 3407, 3408, 3409, 3410, 3411, 3412, 3413, 3414, 3415, 3416, 3417, 3418, 3419, 3420, 3421, 3422, 3423, 3424, 3425, 3426, 3427, 3428, 3429, 3430, 3431, 3432, 3433, 3434, 3435, 3436, 3437, 3438, 3439, 3440, 3441, 3442, 3443, 3444, 3445, 3446, 3447, 3448, 3449, 3450, 3451, 3452, 3453, 3454, 3455, 3456, 3457, 3458, 3459, 3460, 3461, 3462, 3463, 3464, 3465, 3466, 3467, 3468, 3469, 3470, 3471, 3472, 3473, 3474, 3475, 3476, 3477, 3478, 3479, 3480, 3481, 3482, 3483, 3484, 3485, 3486, 3487, 3488, 3489, 3490, 3491, 3492, 3493, 3494, 3495, 3496, 3497, 3498, 3499, 3500, 3501, 3502, 3503, 3504, 3505, 3506, 3507, 3508, 3509, 3510, 3511, 3512, 3513, 3514, 3515, 3516, 3517, 3518, 3519, 3520, 3521, 3522, 3523, 3524, 3525, 3526, 3527, 3528, 3529, 3530, 3531, 3532, 3533, 3534, 3535, 3536, 3537, 3538, 3539, 3540, 3541, 3542, 3543, 3544, 3545, 3546, 3547, 3548, 3549, 3550, 3551, 3552, 3553, 3554, 3555, 3556, 3557, 3558, 3559, 3560, 3561, 3562, 3563, 3564, 3565, 3566, 3567, 3568, 3569, 3570, 3571, 3572, 3573, 3574, 3575, 3576, 3577, 3578, 3579, 3580, 3581, 3582, 3583, 3584, 3585, 3586, 3587, 3588, 3589, 3590, 3591, 3592, 3593, 3594, 3595, 3596, 3597, 3598, 3599, 3600, 3601, 3602, 3603, 3604, 3605, 3606, 3607, 3608, 3609, 3610, 3611, 3612, 3613, 3614, 3615, 3616, 3617, 3618, 3619, 3620, 3621, 3622, 3623, 3624, 3625, 3626, 3627, 3628, 3629, 3630, 3631, 3632, 3633, 3634, 3635, 3636, 3637, 3638, 3639, 3640, 3641, 3642, 3643, 3644, 3645, 3646, 3647, 3648, 3649, 3650, 3651, 3652, 3653, 3654, 3655, 3656, 3657, 3658, 3659, 3660, 3661, 3662, 3663, 3664, 3665, 3666, 3667, 3668, 3669, 3670, 3671, 3672, 3673, 3674, 3675, 3676, 3677, 3678, 3679, 3680, 3681, 3682, 3683, 3684, 3685, 3686, 3687, 3688, 3689, 3690, 3691, 3692, 3693, 3694, 3695, 3696, 3697, 3698, 3699, 3700, 3701, 3702, 3703, 3704, 3705, 3706, 3707, 3708, 3709, 3710, 3711, 3712, 3713, 3714, 3715, 3716, 3717, 3718, 3719, 3720, 3721, 3722, 3723, 3724, 3725, 3726, 3727, 3728, 3729, 3730, 3731, 3732, 3733, 3734, 3735, 3736, 3737, 3738, 3739, 3740, 3741, 3742, 3743, 3744, 3745, 3746, 3747, 3748, 3749, 3750, 3751, 3752, 3753, 3754, 3755, 3756, 3757, 3758, 3759, 3760, 3761, 3762, 3763, 3764, 3765, 3766, 3767, 3768, 3769, 3770, 3771, 3772, 3773, 3774, 3775, 3776, 3777, 3778, 3779, 3780, 3781, 3782, 3783, 3784, 3785, 3786, 3787, 3788, 3789, 3790, 3791, 3792, 3793, 3794, 3795, 3796, 3797, 3798, 3799, 3800, 3801, 3802, 3803, 3804, 3805, 3806, 3807, 3808, 3809, 3810, 3811, 3812, 3813, 3814, 3815, 3816, 3817, 3818, 3819, 3820, 3821, 3822, 3823, 3824, 3825, 3826, 3827, 3828, 3829, 3830, 3831, 3832, 3833, 3834, 3835, 3836, 3837, 3838, 3839, 3840, 3841, 3842, 3843, 3844, 3845, 3846, 3847, 3848, 3849, 3850, 3851, 3852, 3853, 3854, 3855, 3856, 3857, 3858, 3859, 3860, 3861, 3862, 3863, 3864, 3865, 3866, 3867, 3868, 3869, 3870, 3871, 3872, 3873, 3874, 3875, 3876, 3877, 3878, 3879, 3880, 3881, 3882, 3883, 3884, 3885, 3886, 3887, 3888, 3889, 3890, 3891, 3892, 3893, 3894, 3895, 3896, 3897, 3898, 3899, 3900, 3901, 3902, 3903, 3904, 3905, 3906, 3907, 3

Project Design Drawing Notes

1. Drawings issued are for planning application purposes only.
2. Drawings not to be used for construction/contract conditions.
3. Copyright, all rights reserved. No part hereof may be copied or reproduced partially or wholly in any form whatsoever without the prior notice of the copyright owner McCarthy Keville O'Sullivan.
4. Do not scale off this drawing. Figured metric dimensions only should be taken off this drawing.
5. All contractors, whether main or sub-contractors, must visit the site and are responsible for taking and checking any and all dimensions and levels that relate to the works.
6. The use of or reliance upon this drawing shall be deemed to be acceptance of these conditions of use unless otherwise agreed in writing, such written agreement to be sought from and issued by the copyright holder to the use or reliance upon this drawing.
7. Layout plans show typical Turbine rotor diameter as per turbine drawing.
8. Final levels may vary depending on local ground conditions.
9. Exact location of cable/joint bay in the road corridor to be subject to ESB specifications and agreement with Westmeath County Council

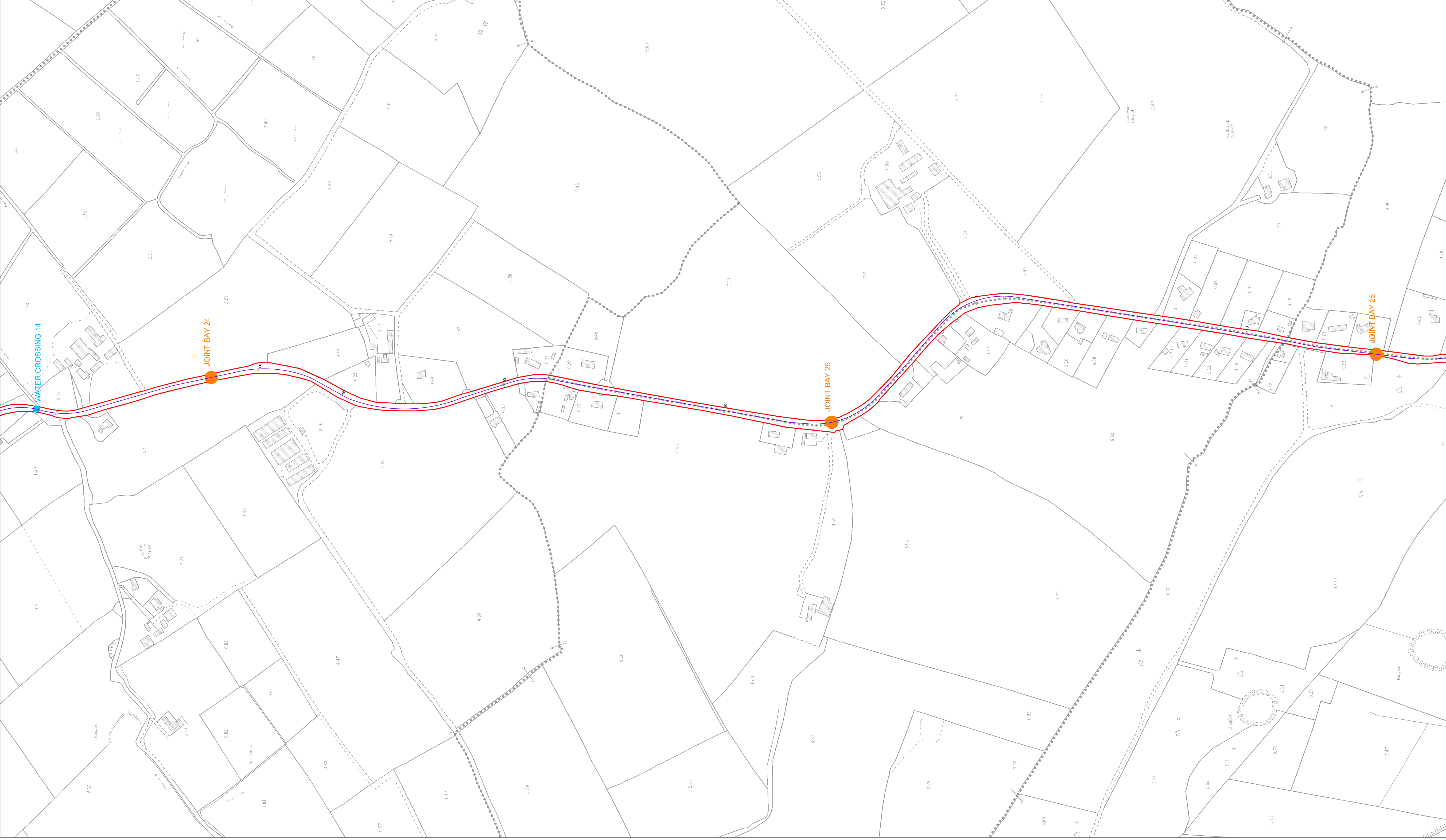

Drawing Legend

- Planning Application Boundary
- Grid Connection Route
- X Spot Height
- Joint Bay
- Watertossing

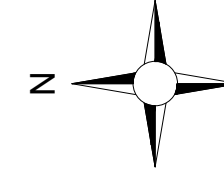

Ordnance Survey Ireland Licence No. CYAL50267517@Ordnance Survey Ireland/Government of Ireland

DRAWING TITLE	
Site Layout Plan Sheet 20 of 24	
PROJECT TITLE	
Coolo Wind Farm FI, Co. Westmeath	
DRAWING BY	CHECKED BY
Joseph O'Brien	Meabhann Crowe
PROJECT No.	DRAWING No.
200445g	200445g - 33 FI
SCALE	DATE
1:2,500 @ A1	27.10.2022
OS SHEET No.	
2004, 2005, 2006, 2007, 2008, 2009, 2010, 2011, 2012, 2013, 2014, 2015, 2016, 2017, 2018, 2019, 2020, 2021, 2022	

MKO
Planning and
Environmental
Consultants
Tuum Road, Galway
Ireland, H91 VW84
+353 (0) 91 735611
email: info@www.mkoireland.ie
Website: www.mkoireland.ie

Project Design Drawing Notes

1. Drawings issued are for planning application purposes only.
2. Drawings not to be used for construction/contract conditions.
3. Copyright, all rights reserved. No part hereof may be copied or reproduced partially or wholly in any form whatsoever without the prior notice of the copyright owner McCarthy Keville O'Sullivan.
4. Do not scale off this drawing. Figured metric dimensions only should be taken off this drawing.
5. All contractors, whether main or sub-contractors, must visit the site and are responsible for taking and checking any and all dimensions and levels that relate to the works.
6. The use of or reliance upon this drawing shall be deemed to be acceptance of these conditions of use unless otherwise agreed in writing, such written agreement to be sought from and issued by the copyright holder to the use or reliance upon this drawing.
7. Layout plans show typical Turbine rotor diameter as per turbine drawing.
8. Final levels may vary depending on local ground conditions.
9. Exact location of cable/joint bay in the road corridor to be subject to ESB specifications and agreement with Westmeath County Council

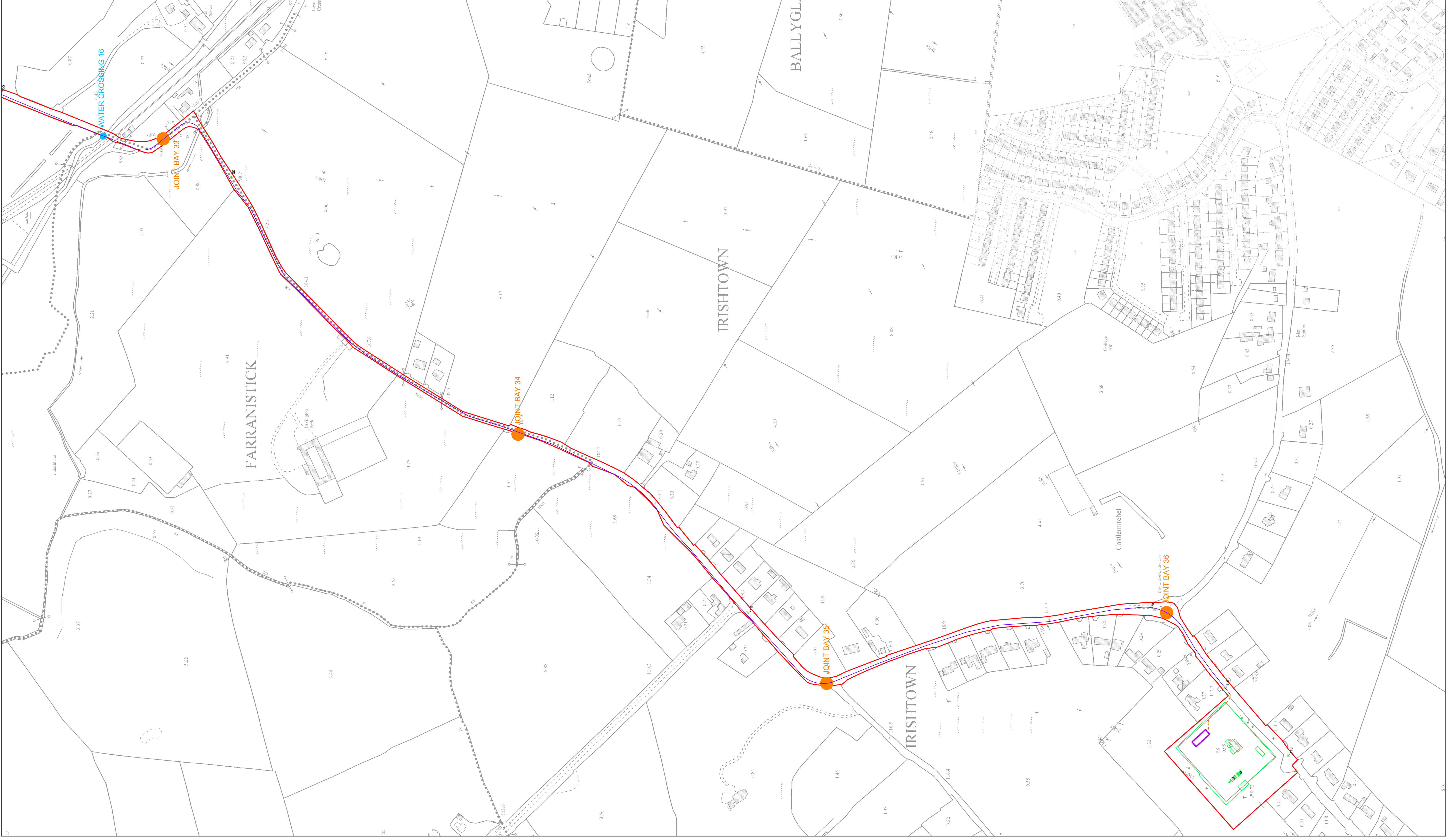

Drawing Legend

- Planning Application Boundary
- Grid Connection Route
- Proposed Cable Alteration
- Existing Mullingar Substation
- X Spot Height
- Joint Bay
- Watercrossing

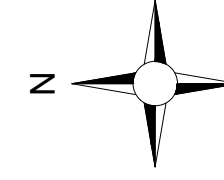

Ordnance Survey Ireland Licence No. CYAL50267517@Ordnance Survey Ireland/Government of Ireland

DRAWING TITLE	
Site Layout Plan Sheet 24 of 24	
PROJECT TITLE	
Coolo Wind Farm FI, Co. Westmeath	
DRAWING BY	CHECKED BY
Joseph O'Brien	Meabhann Crowe
PROJECT No.	DRAWING No.
200445g	200445g - 37 FI
SCALE	DATE
1:2,500 @ A1	27.10.2022
OS SHEET No.	
2004, 2005, 2006, 2007, 2008, 2009, 2010, 2011, 2012, 2013, 2014, 2015, 2016, 2017, 2018, 2019, 2020, 2021, 2022	

MKO
Planning and
Environmental
Consultants
Tuum Road, Galway
Ireland, H91 VW84
+353 (0) 91 735611
email: info@www.mkoireland.ie
Website: www.mkoireland.ie

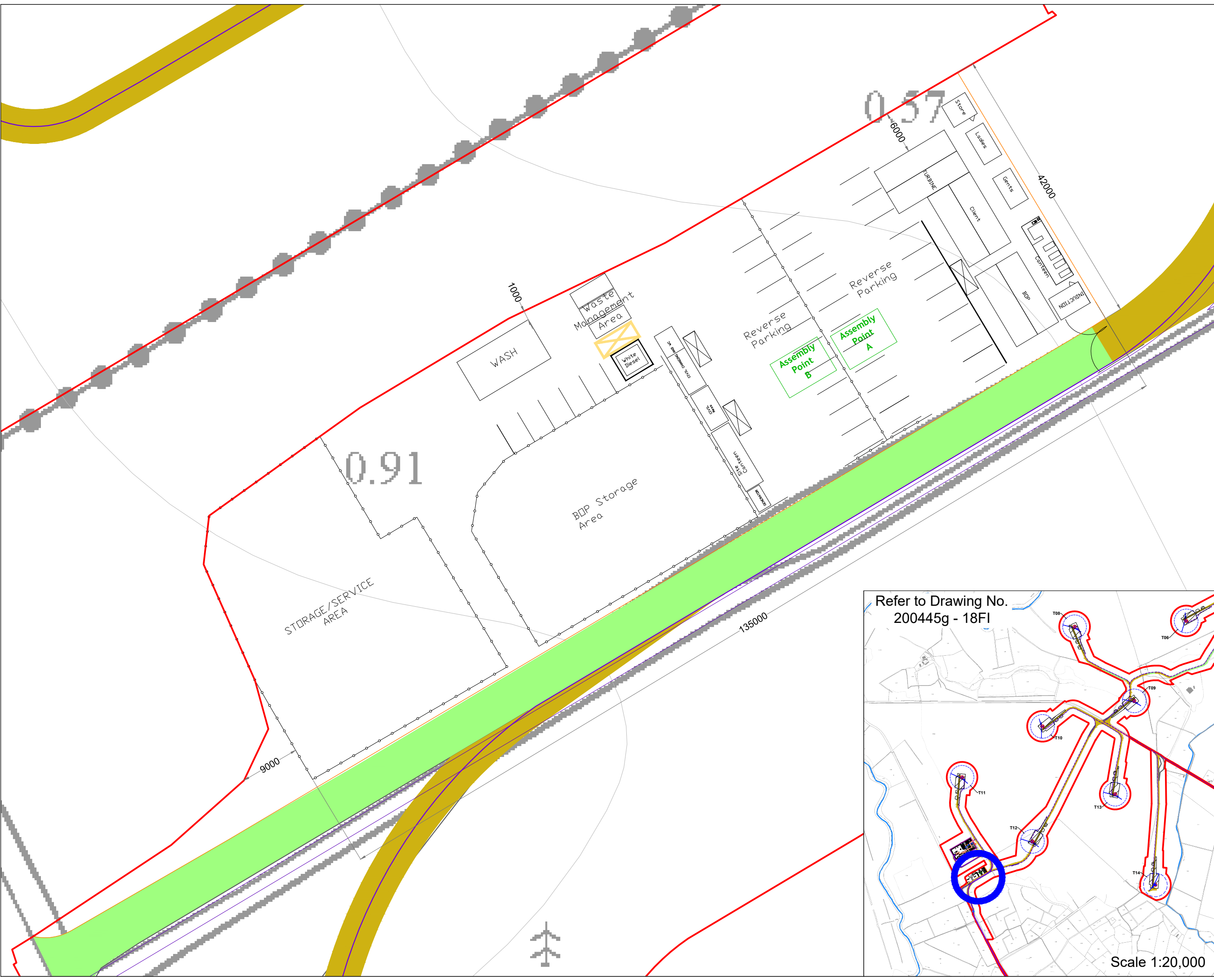

Drawing Legend

- Planning Application Boundary
- Existing Internal Road to be Upgraded
- Proposed Road
- Internal Electrical Cabling
- Temporary Construction Compound
- Grid Connection Route

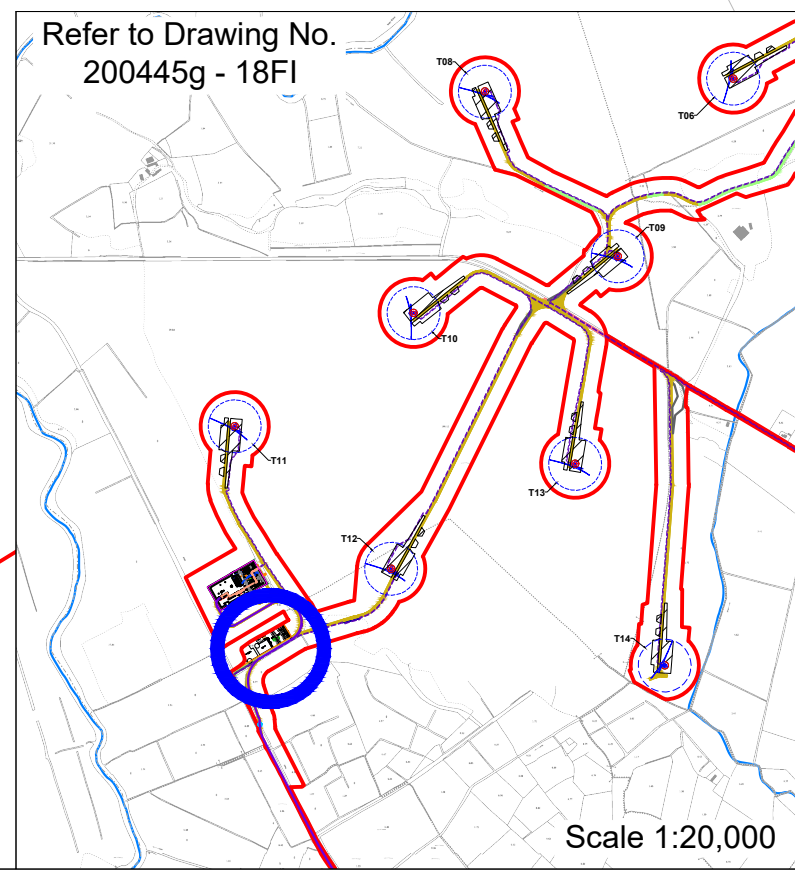

Temporary Construction Compound

PROJECT TITLE: Coole Wind Farm FI, Co. Westmeath

DRAWING BY: Joseph O'Brien	CHECKED BY: Meabhann Crowe
PROJECT No.: 200445g	DRAWING No.: 200445g - 38 FI
SCALE: 1:500 @A3	DATE: 27.10.2022

OS SHEET No.: 228, 227, 228, 229, 230, 231, 232, 233, 234, 235, 236, 237, 238, 239, 240, 241, 242, 243, 244, 245, 246, 247, 248, 249, 250, 251, 252, 253, 254, 255, 256, 257, 258, 259, 260, 261, 262, 263, 264, 265, 266, 267, 268, 269, 270, 271, 272, 273, 274, 275, 276, 277

MKO
 Planning and Environmental Consultants
 Tuam Road, Galway
 Ireland, H91 VW64
 +353 (0) 91 735611
 email: info@www.mkofireland.ie
 Website: www.mkofireland.ie

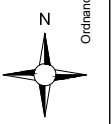

Ordnance Survey Ireland Licence No. CYAL50267517 © Ordnance Survey Ireland/Government of Ireland

Scale 1:20,000

Drawing Notes

1. Layout and arrangements of substation buildings and electrical equipment is shown indicatively and for illustration purposes only as final specifications of buildings and electrical equipment is to be dictated by Eirgrid/ESB networks requirements.



- Drawing Legend**
- Planning Application Boundary
 - Proposed Road
 - Internal Electrical Cabling
 - Grid Connection Route

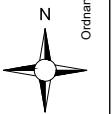

Substation Layout

PROJECT TITLE:
Cooloe Wind Farm FI, Co. Westmeath

DRAWING BY: Joseph O'Brien	CHECKED BY: Meabhann Crowe
PROJECT No.: 200445g	DRAWING No.: 200445g - 39 FI
SCALE: 1:500 @A3	DATE: 27.10.2022

OS SHEET No.: 228, 227, 228, 229, 230, 231, 232, 233, 234, 235, 236, 242, 243, 247, 248, 249, 244, 246, 248, 249, 250, 251, 252, 253, 254, 255, 256, 257, 258, 259, 260, 261, 262, 263, 264, 265, 266, 267, 268, 269, 270, 271, 272, 273, 274, 275, 276, 277



MKO
Planning and Environmental Consultants
Tuam Road, Galway
Ireland: H91 VM94
+353 (0) 91 735611
email: info@www.mkofireland.ie
Website: www.mkofireland.ie

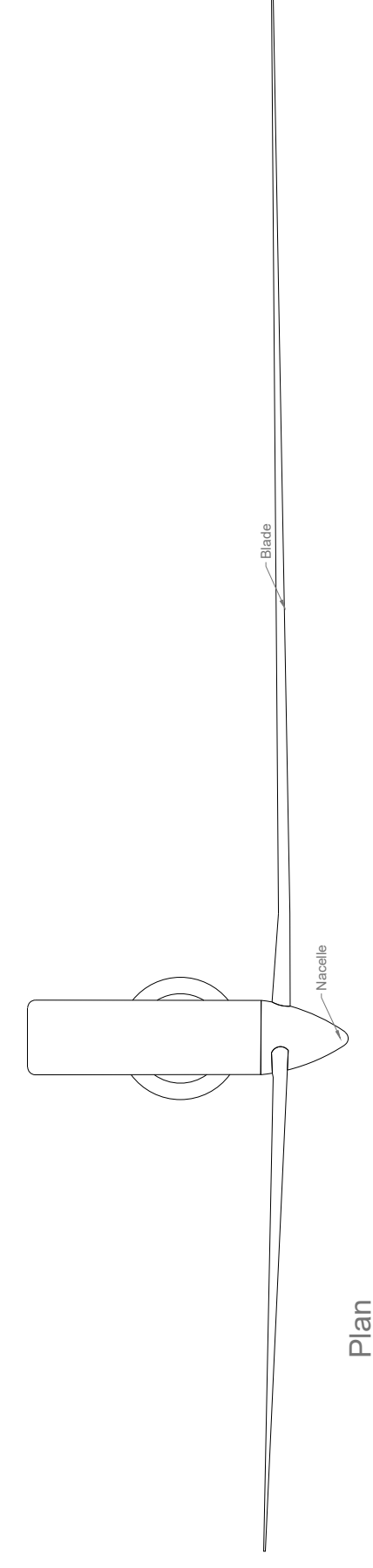
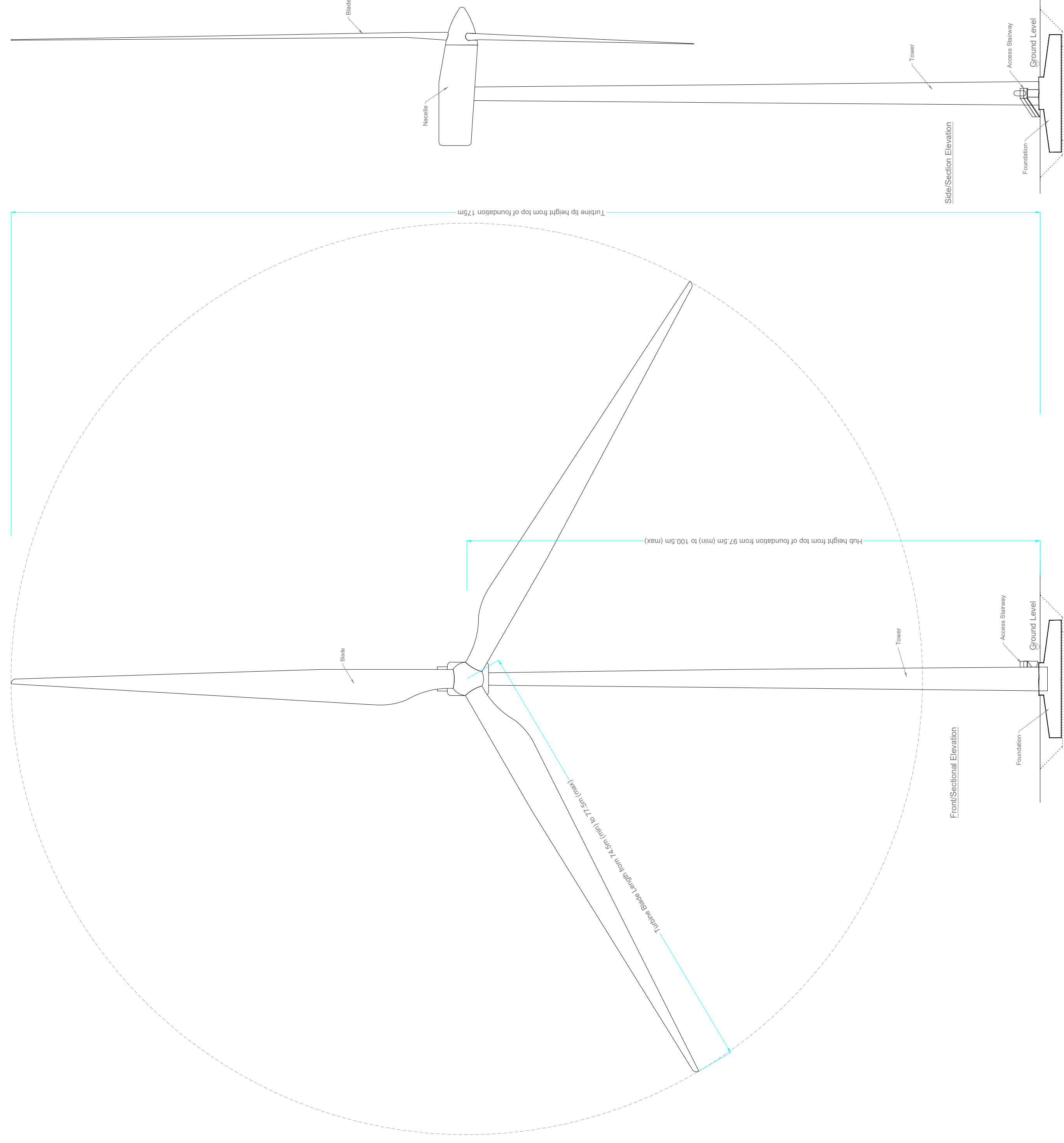

Drawing Notes

1. Proposed wind turbines to have a maximum ground to blade tip height of 175m.
2. Exact make and model of the turbine to be dictated by a competitive tender process.
3. Installed wind turbine not to exceed maximum size envelope set out above in any blade length and hub-height configuration.
4. Turbine foundation diameter may vary.
5. Ground level represents the top of turbine foundation.

DRAWING TITLE:

Wind Turbine Range Elevations & Plan

PROJECT TITLE:

Coole Wind Farm FI, Co. Westmeath

DRAWING BY: **Joseph O Brien**

CHECKED BY: **Meabhann Crowe**

PROJECT NO: **200445g**

DRAWING NO: **200445g - 42A FI**

SCALE: **1:500 @A1**

DATE: **27.10.2022**



MKO

Tuam Road, Galway
 Ireland, H91 VW84
 +353 (0) 91 759511
 email: info@www.mkoireland.ie
 Website: www.mkoireland.ie

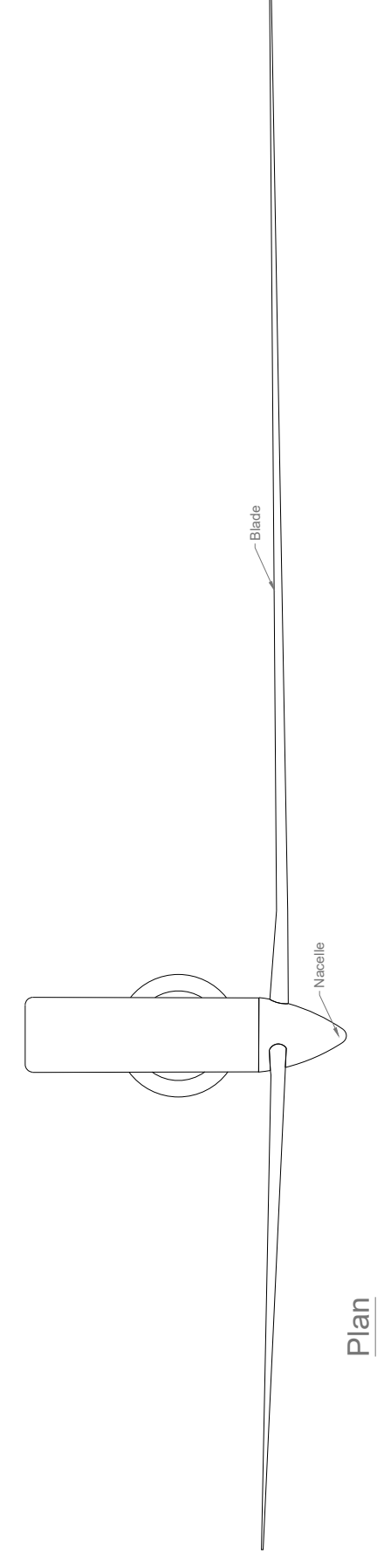
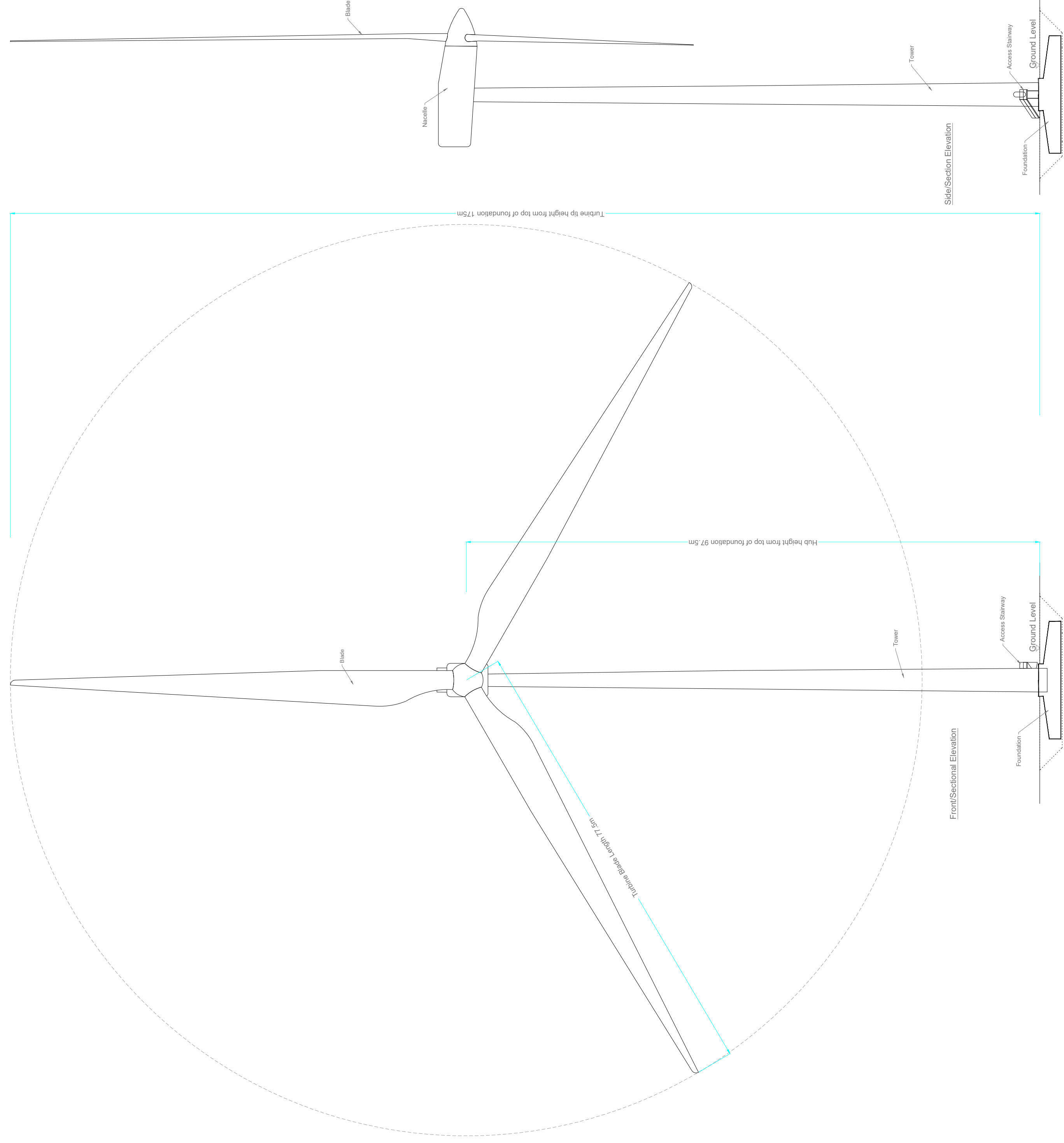

Drawing Notes

1. Proposed wind turbines to have a maximum ground to blade tip height of 175m.
2. Exact make and model of the turbine to be dictated by a competitive tender process.
3. Installed wind turbine not to exceed maximum size envelope set out above in any blade length and hub-height configuration.
4. Turbine foundation diameter may vary.
5. Ground level represents the top of turbine foundation.

DRAWING TITLE	
97.5m hub and 77.5m blade Wind Turbine Elevations & Plan	
PROJECT TITLE	
Coole Wind Farm FI, Co. Westmeath	
DRAWING BY	CHECKED BY
Joseph O Brien	Meabhann Crowe
PROJECT NO.	DRAWING NO.
200445g	200445g -42B FI
SCALE	DATE
1:500 @A1	27.10.2022



MKO
 Tuam Road, Galway
 Ireland, H91 VW84
 +353 (0) 91 759511
 email: info@www.mkoireland.ie
 Website: www.mkoireland.ie

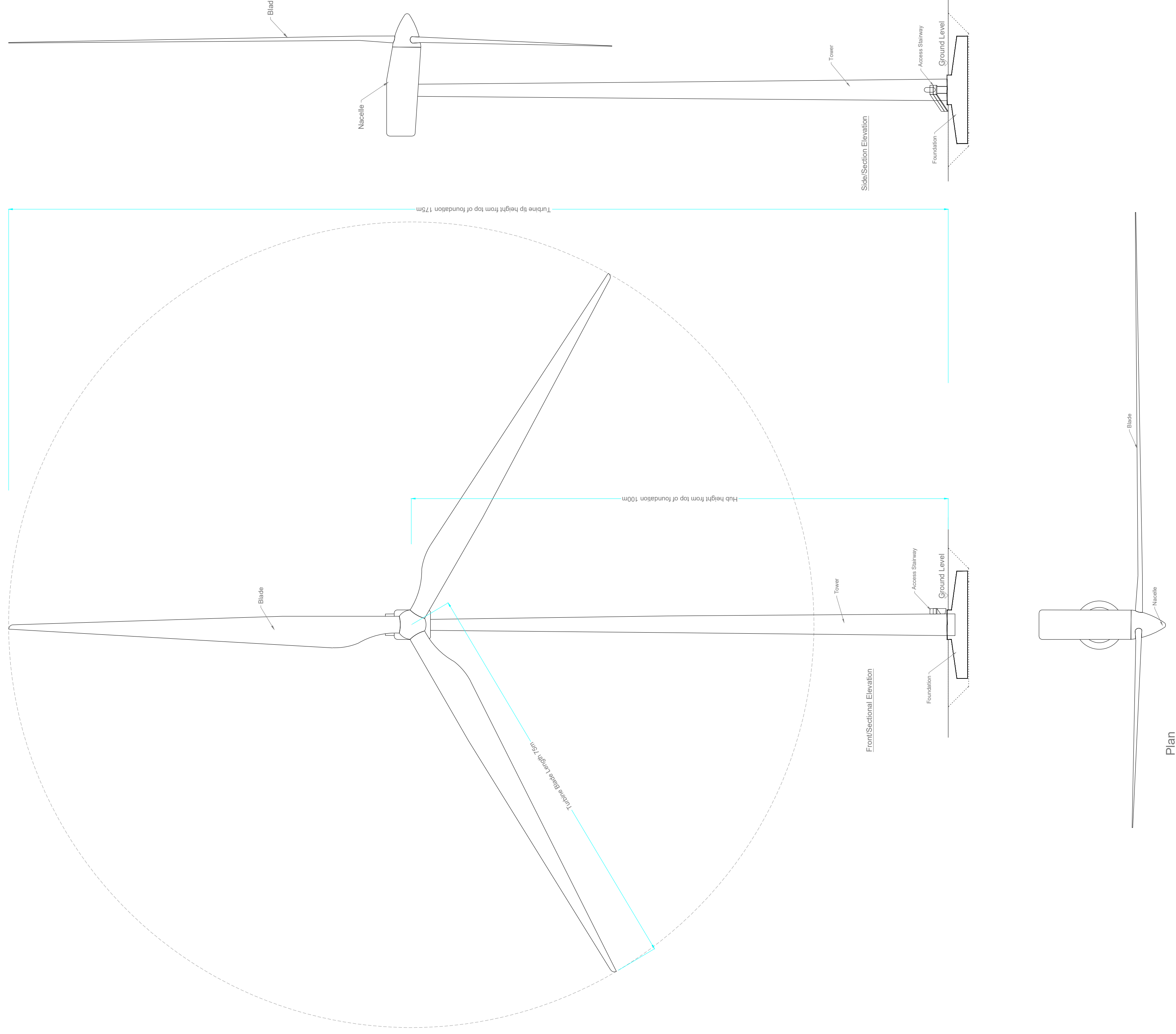

Drawing Notes

- Proposed wind turbines to have a maximum ground to blade tip height of 175m.
- Exact make and model of the turbine to be dictated by a competitive tender process.
- Installed wind turbine not to exceed maximum size envelope set out above in any blade length and hub-height configuration.
- Turbine foundation diameter may vary.
- Ground level represents the top of turbine foundation.

DRAWING TITLE: 100m hub and 75m blade Wind Turbine Elevations & Plan	
PROJECT TITLE: Coole Wind Farm FI, Co. Westmeath	
DRAWING BY: Joseph O'Brien	CHECKED BY: Meabhann Crowe
PROJECT NO: 200445g	DRAWING NO: 200445g -42C FI
SCALE: 1:500 @A1	DATE: 27.10.2022



MKO
 Tuam Road, Galway
 Ireland, H91 VW84
 +353 (0) 91 759511
 email: info@www.mkoreland.ie
 Website: www.mkoreland.ie

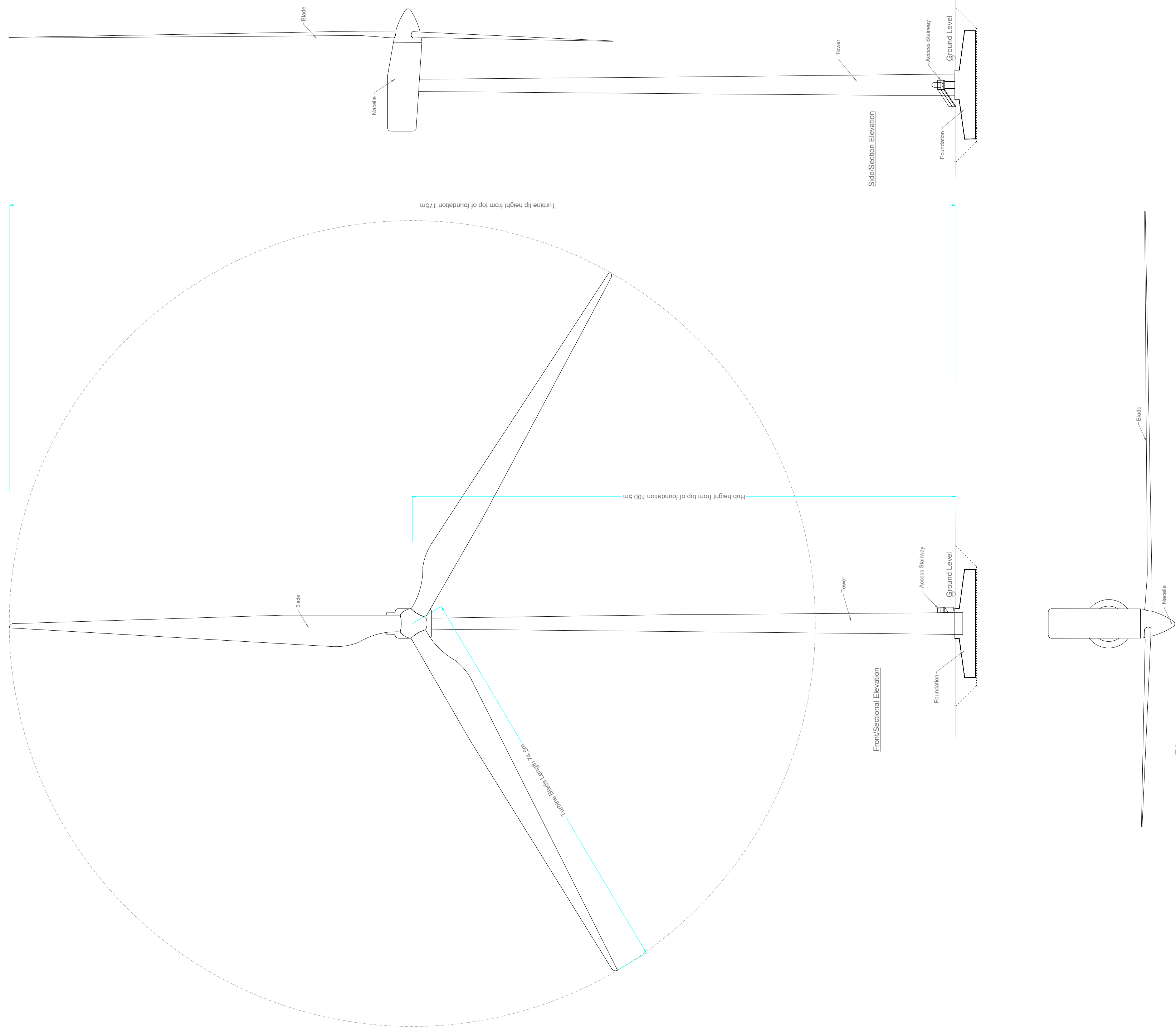

Drawing Notes

- Proposed wind turbines to have a maximum ground to blade tip height of 175m.
- Exact make and model of the turbine to be dictated by a competitive tender process.
- Installed wind turbine not to exceed maximum size envelope set out above in any blade length and hub-height configuration.
- Turbine foundation diameter may vary.
- Ground level represents the top of turbine foundation.

DRAWING TITLE: 100.5m hub and 74.5m blade Wind Turbine Elevations & Plan	
PROJECT TITLE: Coole Wind Farm FI, Co. Westmeath	
DRAWING BY: Joseph O Brien	CHECKED BY: Meabhann Crowe
PROJECT NO: 200445g	DRAWING NO: 200445g -42D FI
SCALE: 1:500 @A1	DATE: 27.10.2022



MKO
 Tuam Road, Galway
 Ireland, H91 VW84
 +353 (0) 91 759511
 email: info@www.mkofireland.ie
 Website: www.mkofireland.ie

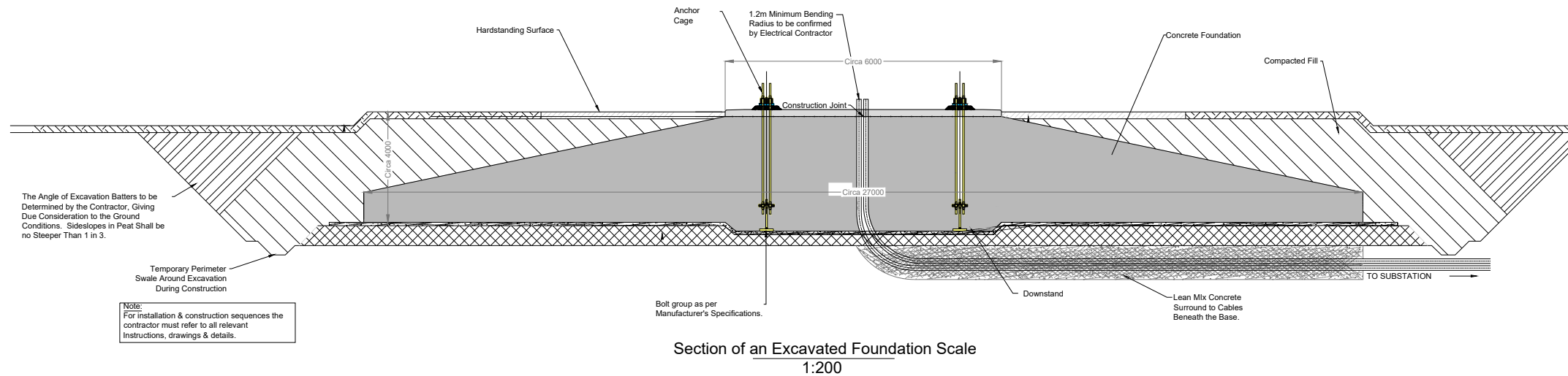

Section of an Excavated Foundation Scale 1:200

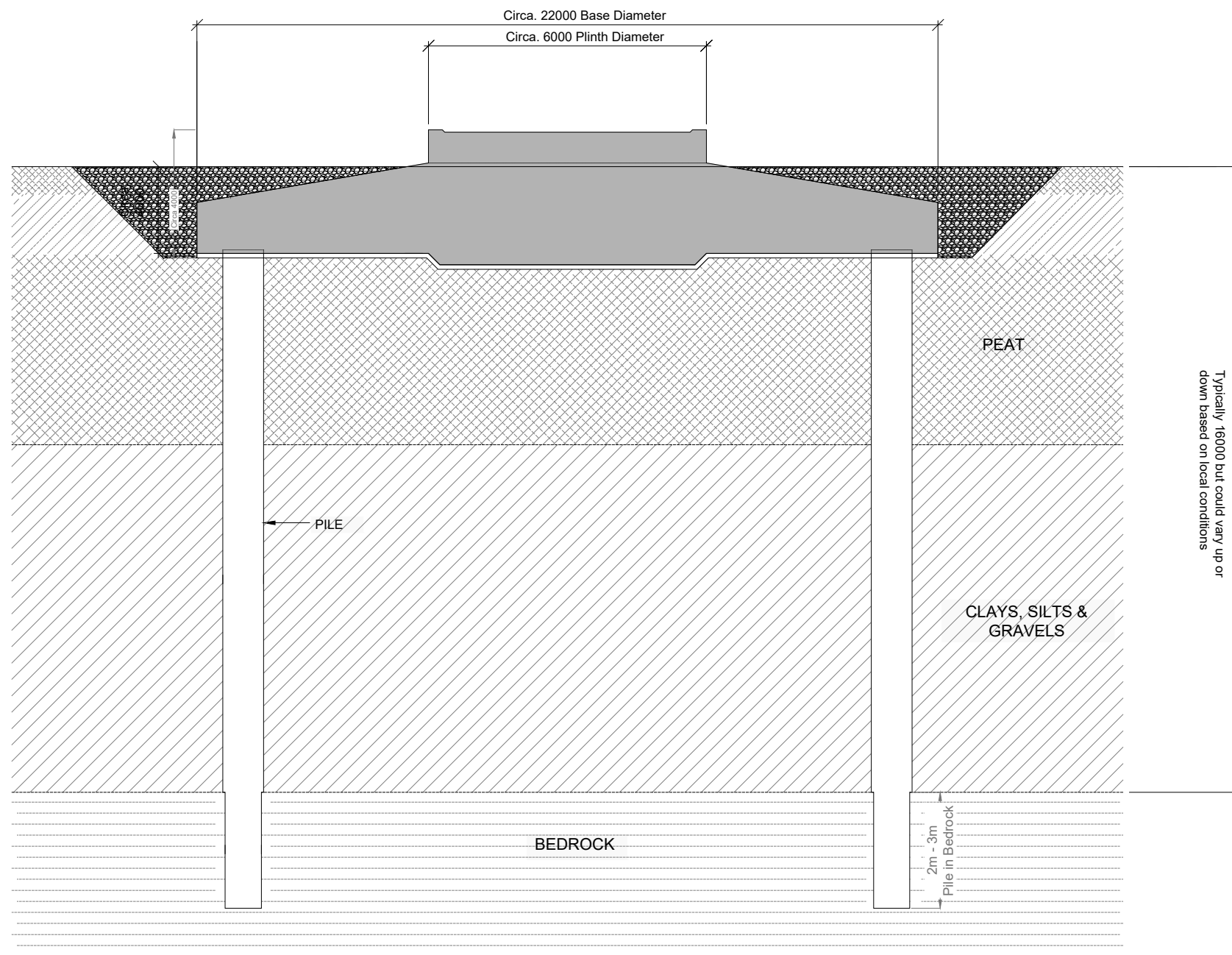

Section of a Piled a Foundation Scale 1:200

Drawing Notes

- Bedrock depth ranges from 8.7m to 16.9m
- Details/dimensions are provided for indicative purposes and will be subject to detailed design by the appointed contractor
- Piles are typically 900 to 1200mm diameter, reinforced concrete installed by bored or continuous flight auger methods and are typically socketed 2 to 3m into competent bedrock
- Excavated material will be placed/spread locally alongside the excavations of the infrastructure elements or where required removed to an appropriately licensed facility

DRAWING TITLE: Turbine Foundation Standard Detail	
PROJECT TITLE: Coole Wind Farm FI, Co. Westmeath	
DRAWING BY: Joseph O'Brien	CHECKED BY: Meabhann Crowe
PROJECT No: 200445g	DRAWING No: 200445g - 43 FI
SCALE: 1:200@A3	DATE: 27.10.2022
	
MKO Planning and Environmental Consultants Tuam Road, Galway Ireland, H91 VW84 +353 (0) 91 735611 email: info@www.mkofireland.ie Website: www.mkofireland.ie	

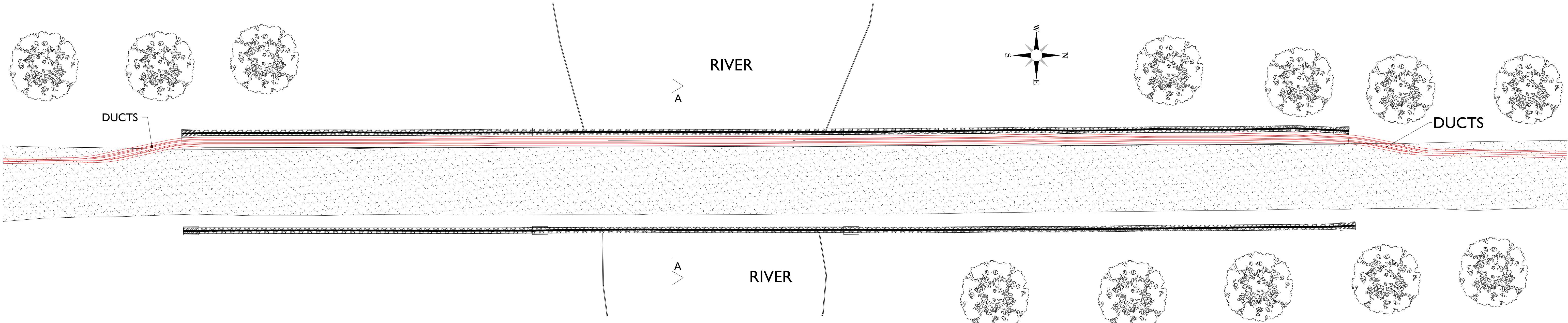

PLAN - PROPOSED OPTION DUCTS PLACED IN ROAD
SCALE 1:125

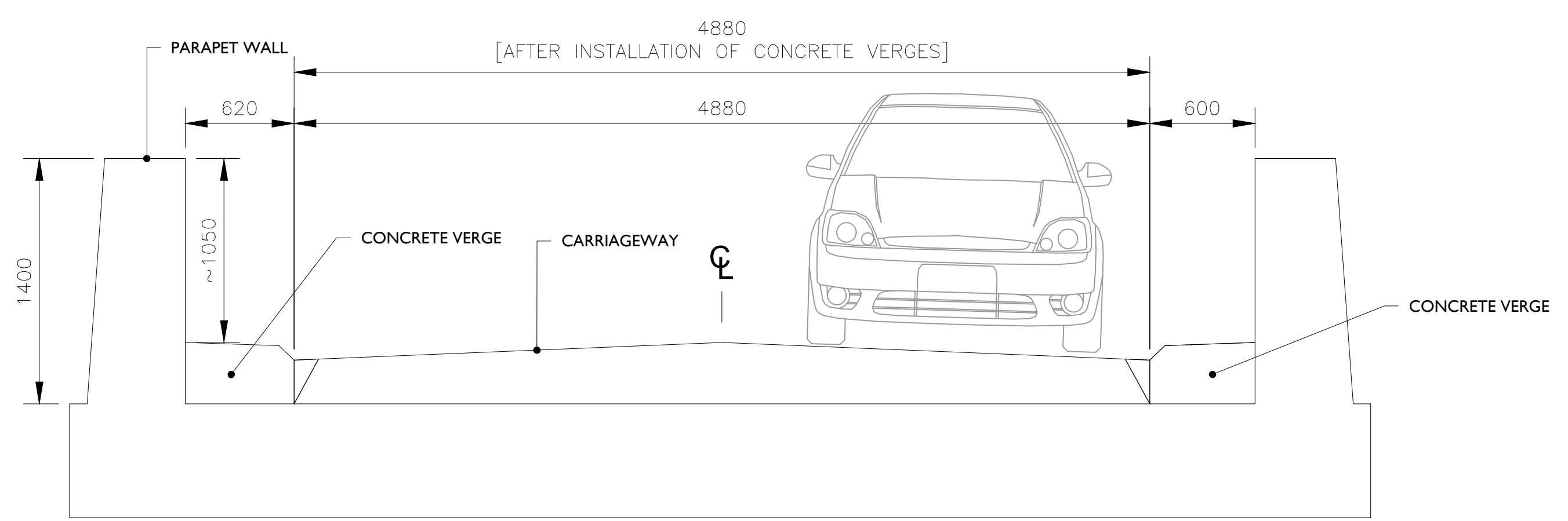

SECTION: EXISTING BRIDGE
SCALE 1:25

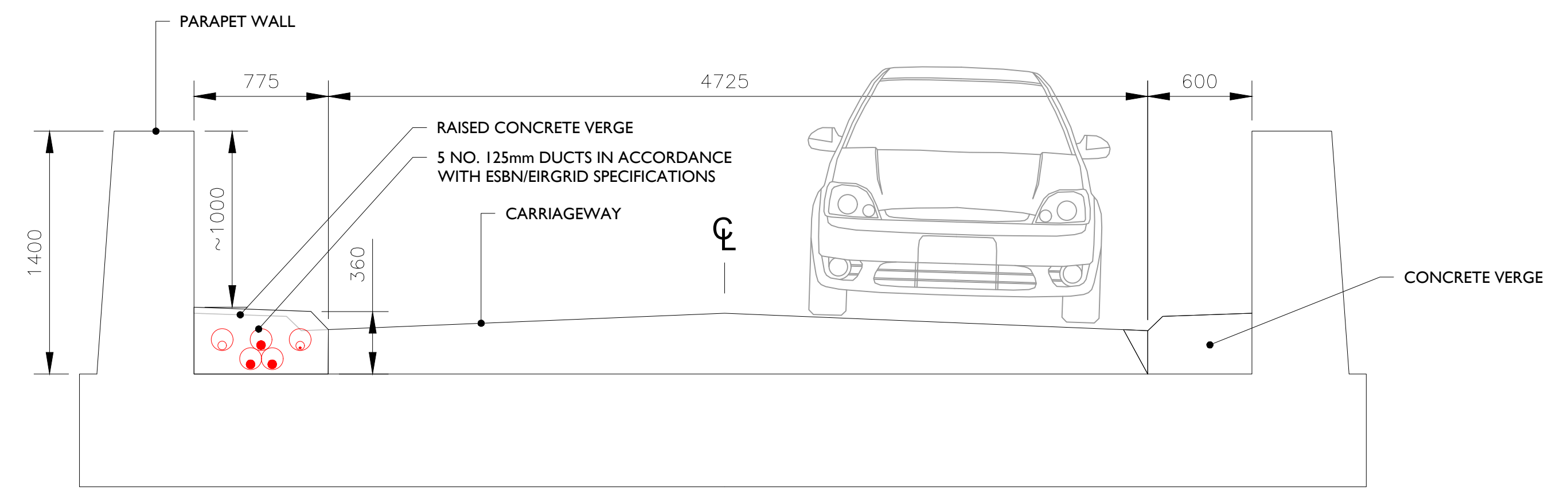

SECTION A-A - PROPOSED OPTION C DUCTS IN CONCRETE VERGE
SCALE 1:25



WH-1825-002.00 BRIDGE LOCATION

NOTES					ENGINEER  The Hyde Building, The Park, Carrickmines, Dublin 18, D18VC44, Ireland E: hello@ionicconsulting.ie T: +353 (0) 1 845 5031 W: www.ionicconsulting.ie		CLIENT		PROJECT		REVISION	
B 25/10/2022 M.B. C.O.D. GENERAL REVISION - REVISED TO "OPTION C" A 28/09/2022 E.A. J.S. FIRST ISSUE					DRAWN BY E. ANDRADE		DATE 07/10/2022		PAPER SIZE A1		SCALE 1:25 / 1:125	
REV DATE DRAWN BY CHECKED BY DETAILS					CHECKED AND APPROVED J. SHANAHAN		DATE 07/10/2022		STATUS DRAFT		DRAWING NUMBER COLE d005.3.3	
										COOLE WIND FARM GRID ROUTE CLONAVA BRIDGE CROSSING WH-L1825-001.00 PROPOSED OPTION C		B

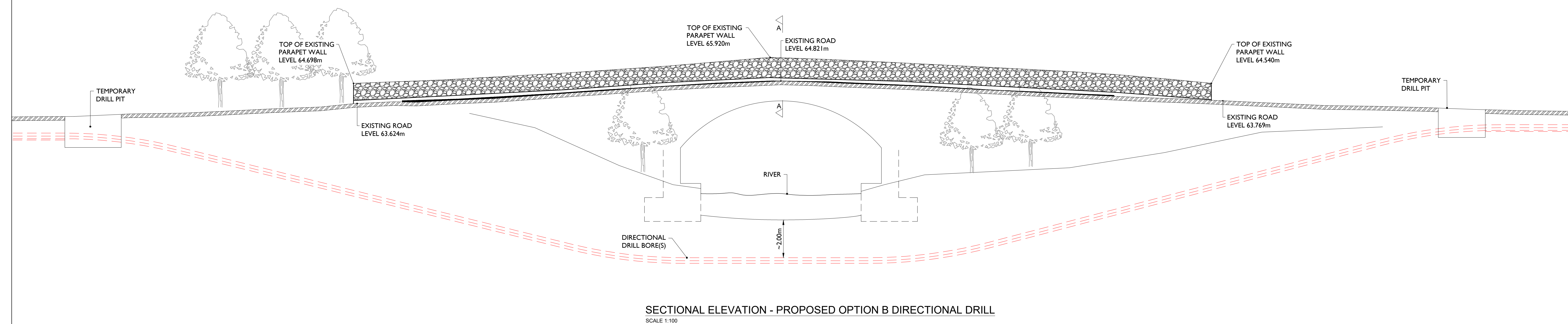
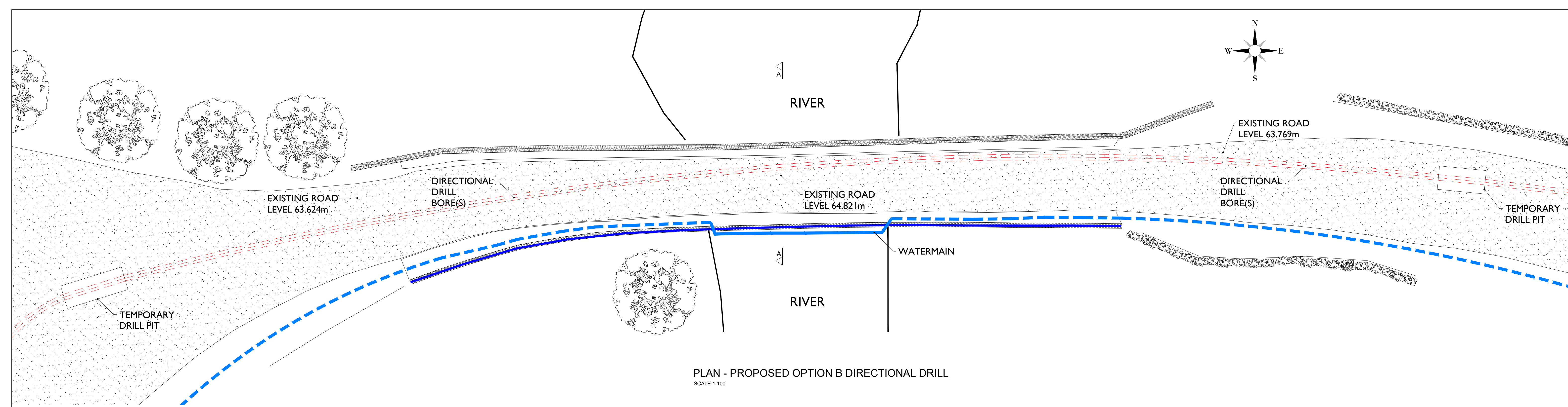

WH-1825-002.00 BRIDGE LOCATION

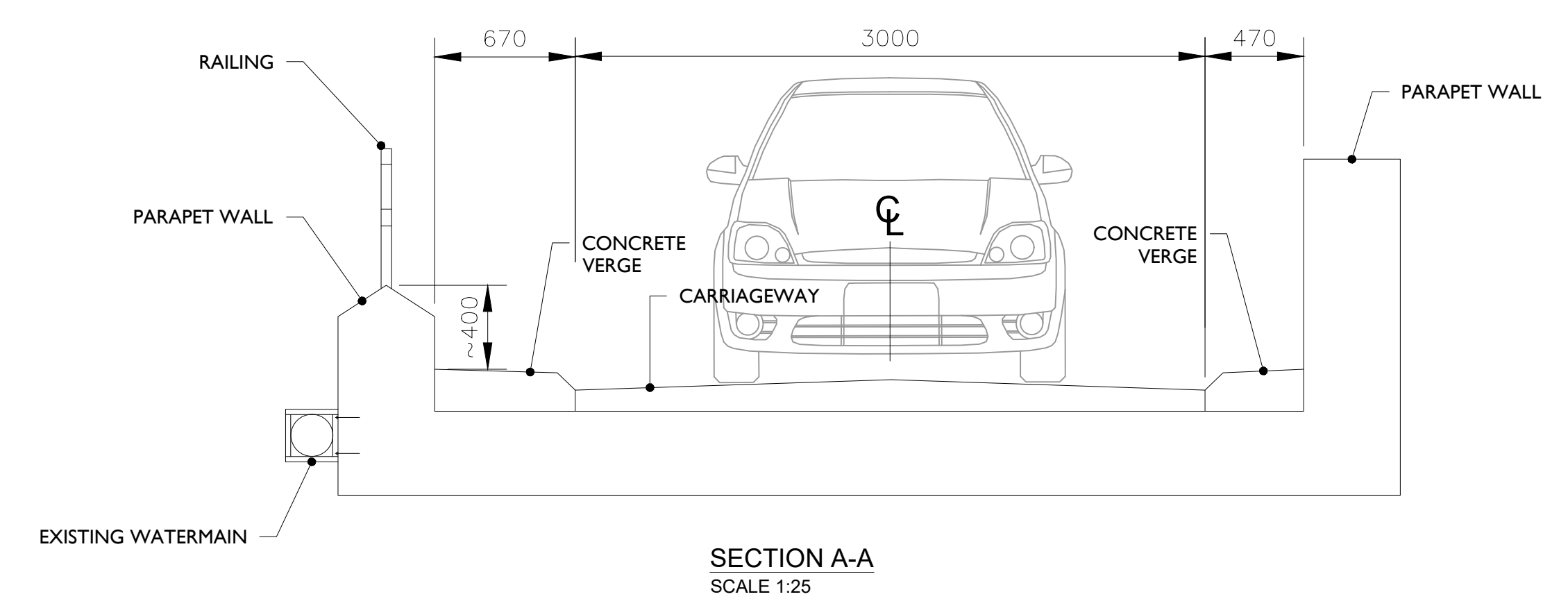

NOTES

REV	DATE	DRAWN BY	CHECKED BY	DETAILS
C	27/10/2022	E.A.	J.S.	WATERMAIN ADDED
B	26/10/2022	M.B.	J.S.	"OPTION A" RENAMED TO "OPTION B"
A	07/10/2022	E.A.	J.S.	FIRST ISSUE

ENGINEER	IONIC CONSULTING		The Hyde Building, The Park, Carrickmines, Dublin 18, D18VC44, Ireland E: hello@ionicconsulting.ie T: +353 (0) 1 845 5031 W: www.ionicconsulting.ie	
DRAWN BY	E. ANDRADE	DATE	07/10/2022	
CHECKED AND APPROVED	J. SHANAHAN	DATE	07/10/2022	

CLIENT	PROJECT		COOLE WIND FARM GRID ROUTE	
PAPER SIZE	A1	SCALE	1:100 / 1:25	
STATUS	DRAFT		DRAWING NUMBER	COLE d005.3.4

TITLE	SHRUBBYWOOD BRIDGE CROSSING WH-L1825-002.00 PROPOSED OPTION B		REVISION	C
-------	---	--	----------	---

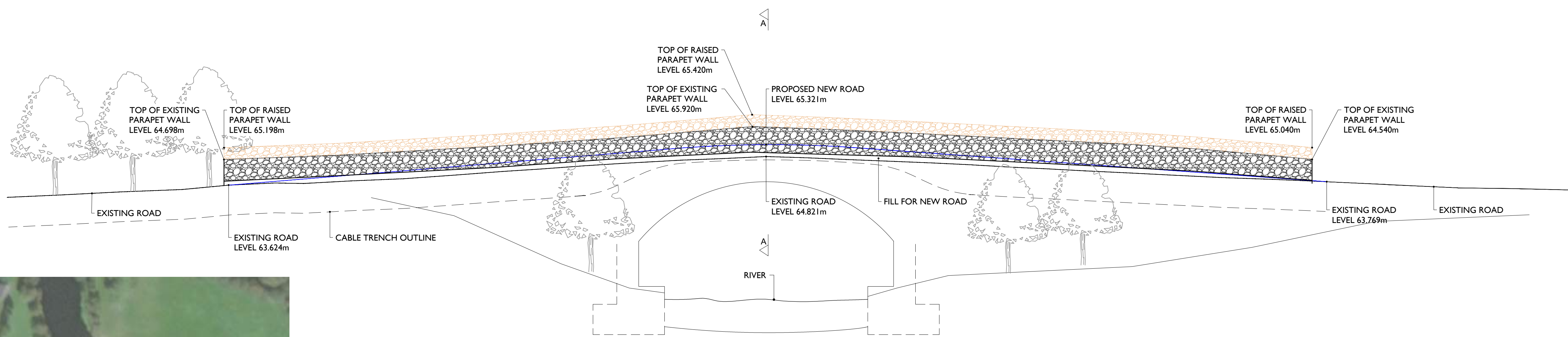
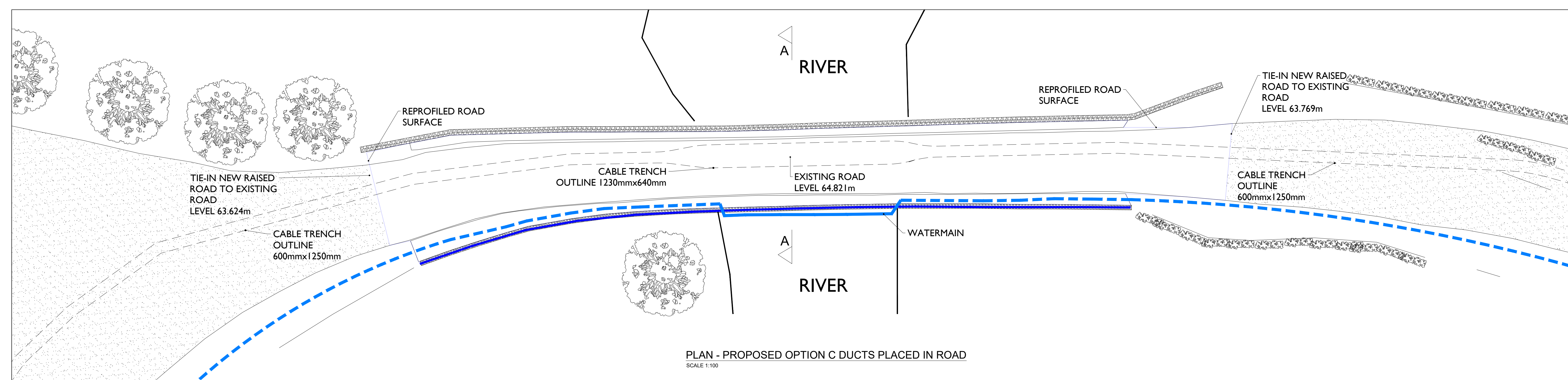

WH-1825-002.00 BRIDGE LOCATION

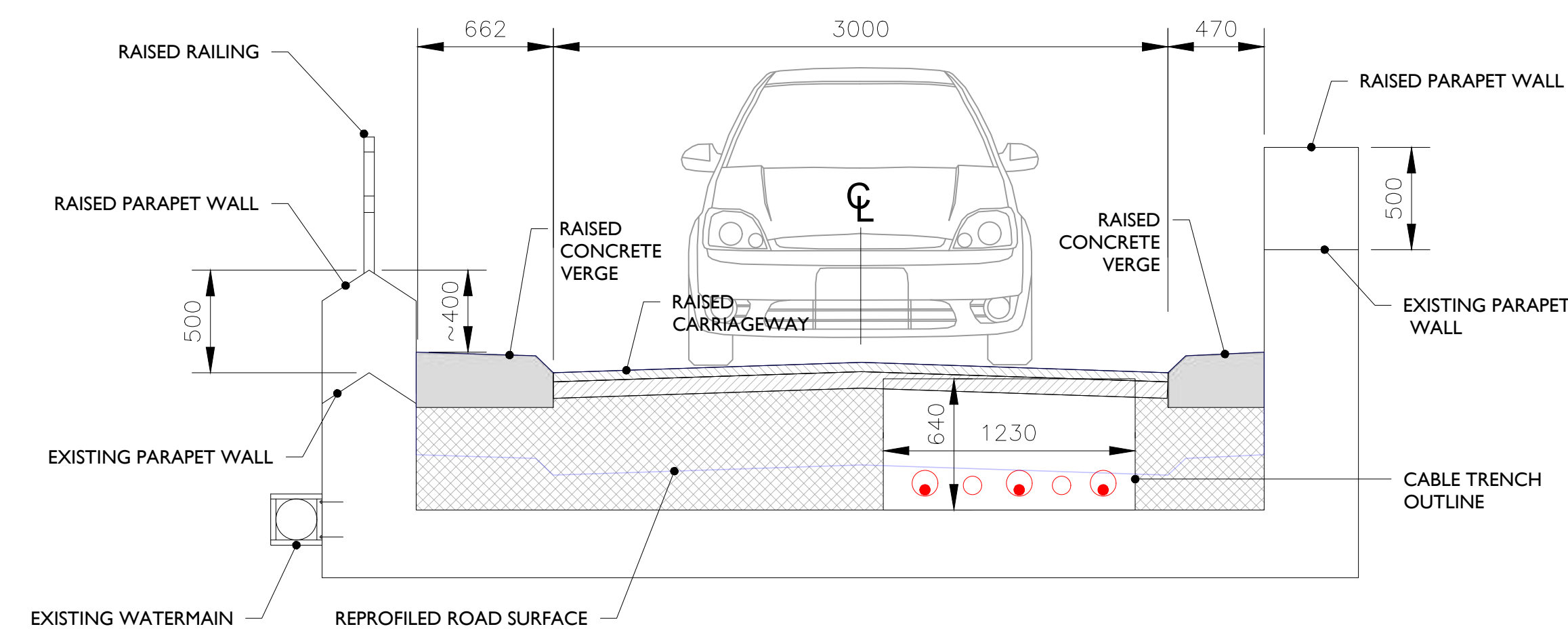
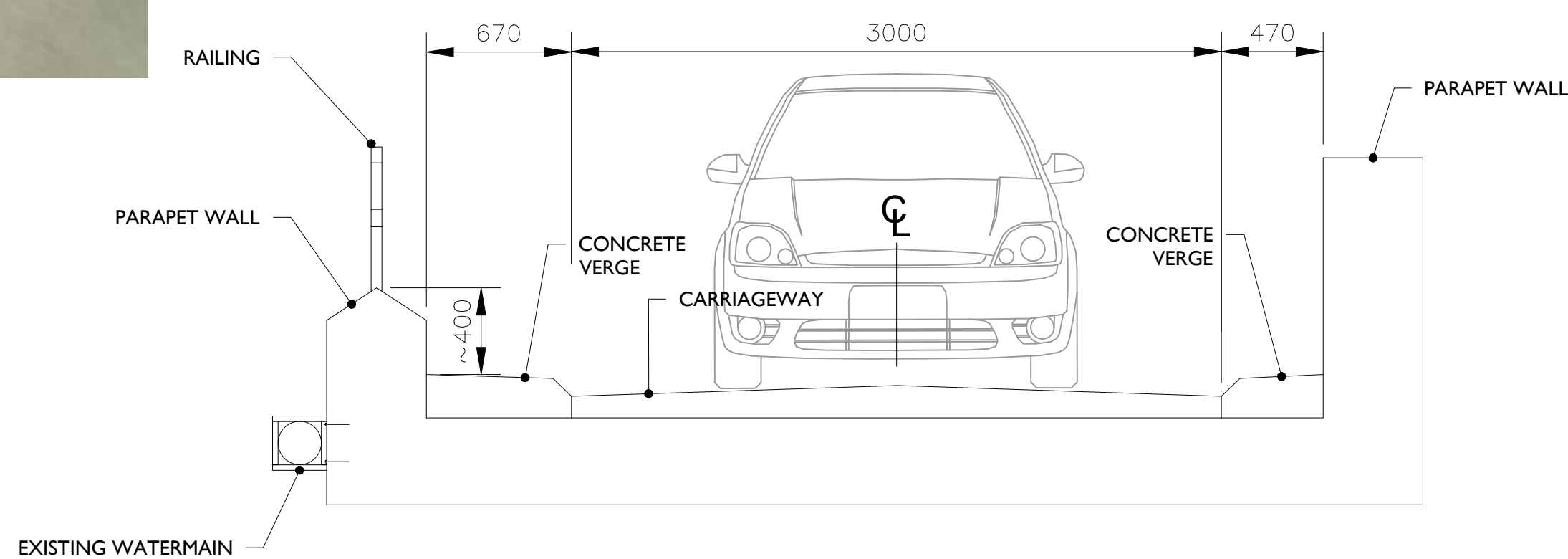

NOTES

REV	DATE	DRAWN BY	CHECKED BY	DETAILS
C	27/10/2022	E.A.	J.S.	WATERMAIN ADDED
B	26/10/2022	M.B.	J.S.	"OPTION B" RENAMED TO "OPTION C"
A	07/10/2022	E.A.	J.S.	FIRST ISSUE

ENGINEER

 The Hyde Building, The Park, Carrickmines, Dublin 18, D18VC44, Ireland
 E: hello@ionicconsulting.ie
 T: +353 (0) 1 845 5031
 W: www.ionicconsulting.ie

CLIENT

DRAWN BY
E. ANDRADE

CHECKED AND APPROVED
J. SHANAHAN

DATE
07/10/2022

PROJECT
**COOLE WIND FARM
 GRID ROUTE**

TITLE
**SHRUBBYWOOD BRIDGE CROSSING
 WH-L1825-002.00 PROPOSED OPTION C**

REVISION
C

PAPER SIZE
A1

SCALE
1:100 / 1:25

STATUS
DRAFT

DRAWING NUMBER
COLE d005.3.5

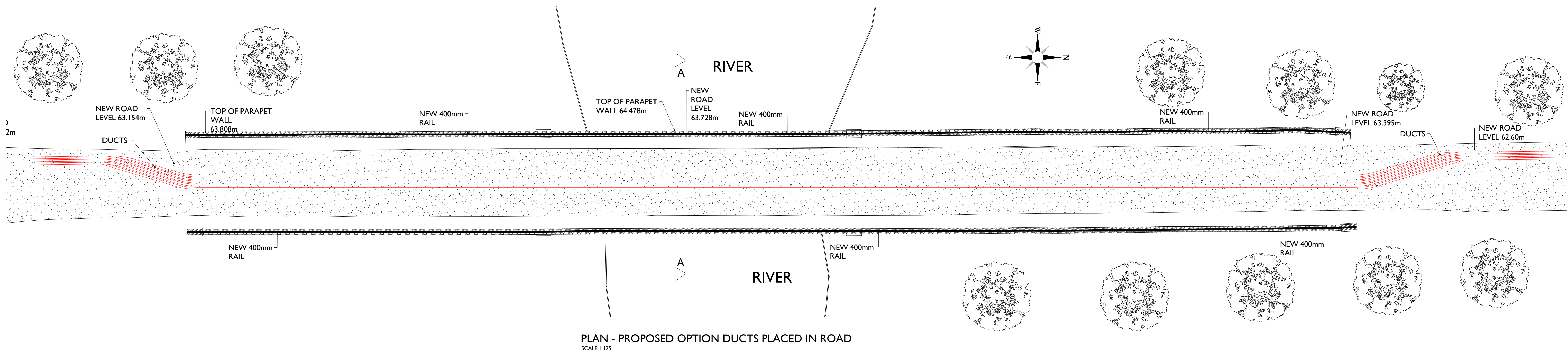

PLAN - PROPOSED OPTION DUCTS PLACED IN ROAD
SCALE 1:125

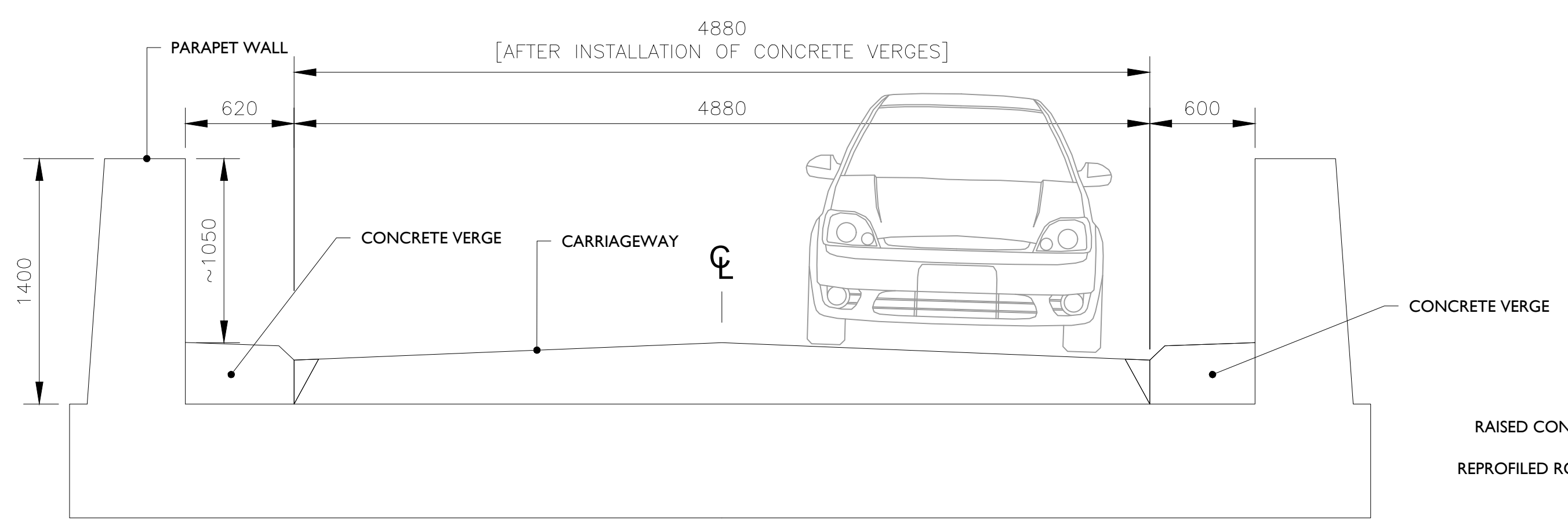

SECTION: EXISTING BRIDGE
SCALE 1:25

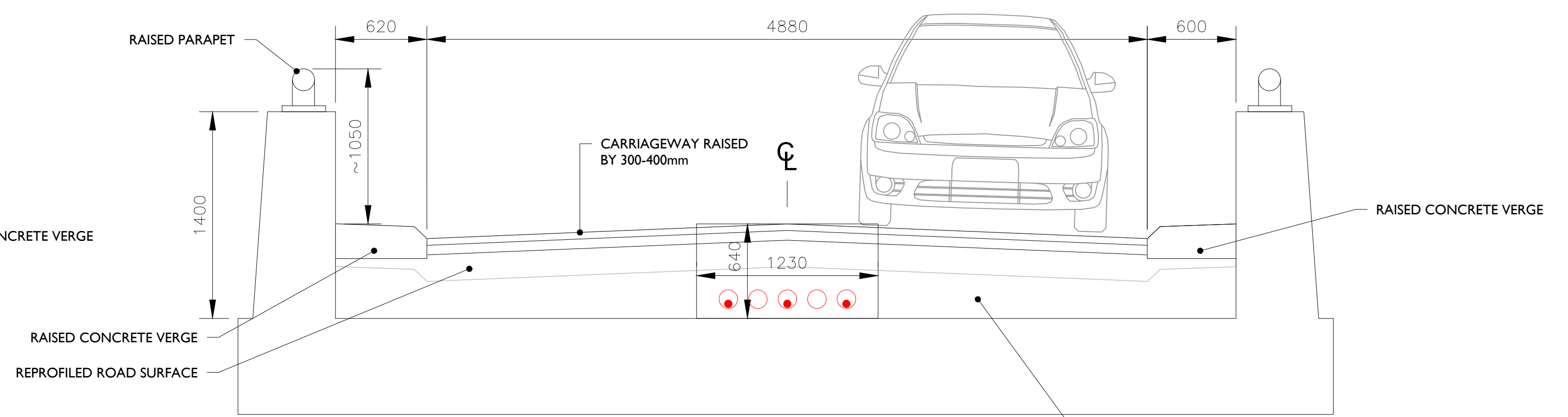

SECTION A-A - PROPOSED OPTION D DUCTS IN ROAD
SCALE 1:25

ROAD LEVEL RAISED USING A LIGHTWEIGHT FILL (E.G. FOAMED CONCRETE). MATERIAL SPECIFICATION TO BE CONFIRMED & AGREED WITH THE LOCAL AUTHORITY.



WH-1825-002.00 BRIDGE LOCATION

NOTES					 <p>The Hyde Building, The Park, Carrickmines, Dublin 18, D18VC44, Ireland E: hello@ionicconsulting.ie T: +353 (0) 1 845 5031 W: www.ionicconsulting.ie</p>		CLIENT		PROJECT											
					DRAWN BY M. BROWNE		DATE 25/10/2022		PAPER SIZE A1											
					CHECKED AND APPROVED J. SHANAHAN		DATE 25/10/2022		SCALE 1:25 / 1:125											
							STATUS DRAFT		DRAWING NUMBER COLE d005.3.6											
									TITLE CLONAVA BRIDGE CROSSING WH-L1825-001.00 PROPOSED OPTION D											
									REVISION A											
<table border="1"> <tr> <th>REV</th> <th>DATE</th> <th>DRAWN BY</th> <th>CHECKED BY</th> <th>DETAILS</th> </tr> <tr> <td>A</td> <td>25/10/2022</td> <td>E.A.</td> <td>J.S.</td> <td>FIRST ISSUE</td> </tr> </table>					REV	DATE	DRAWN BY	CHECKED BY	DETAILS	A	25/10/2022	E.A.	J.S.	FIRST ISSUE						
REV	DATE	DRAWN BY	CHECKED BY	DETAILS																
A	25/10/2022	E.A.	J.S.	FIRST ISSUE																

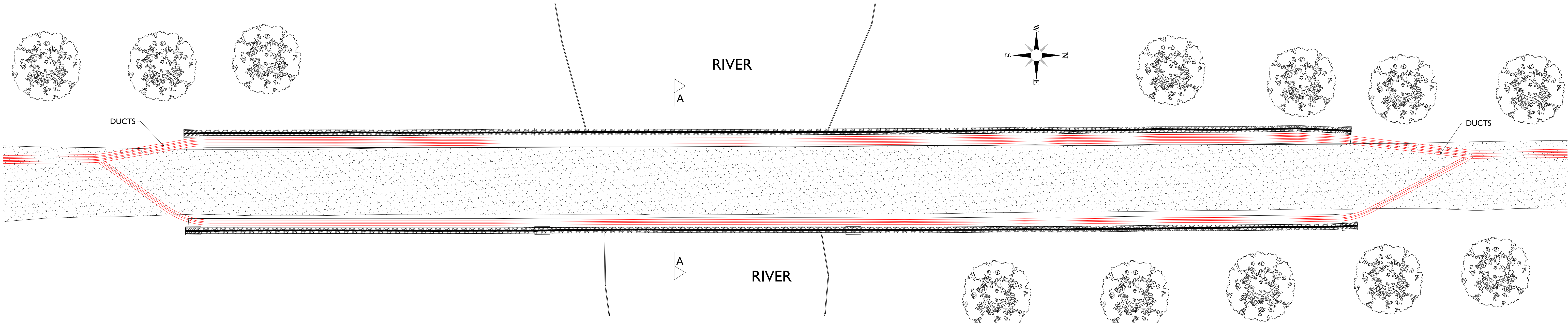

PLAN - PROPOSED OPTION DUCTS PLACED IN ROAD
SCALE 1:125

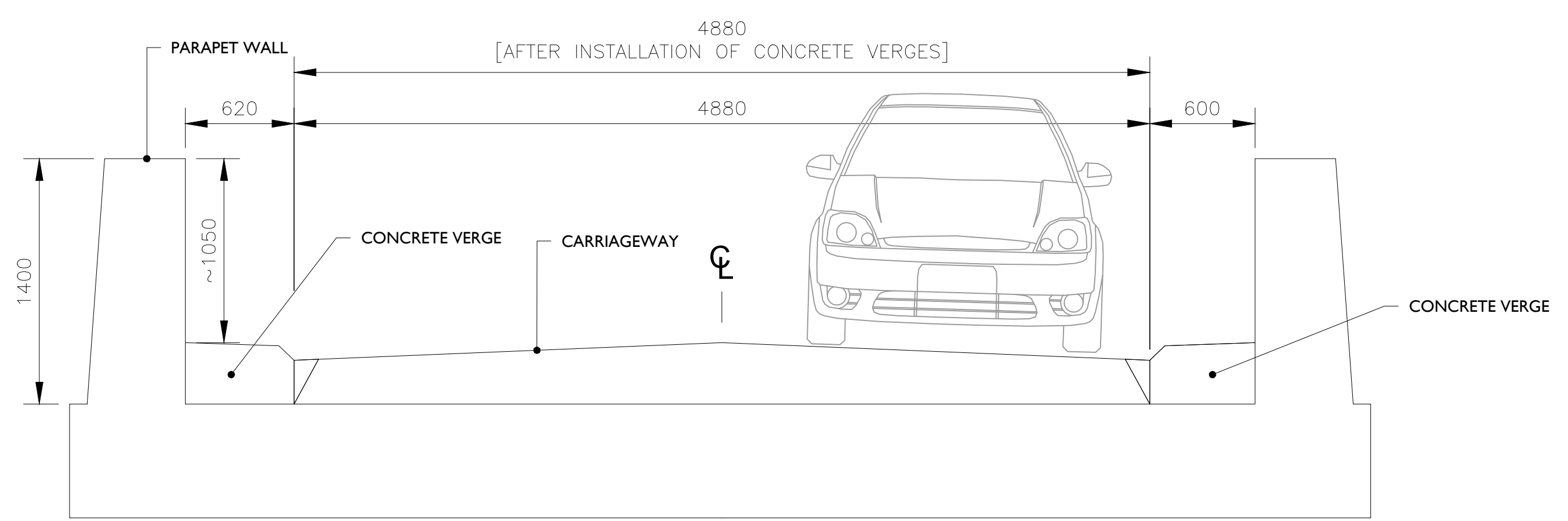

SECTION: EXISTING BRIDGE
SCALE 1:25

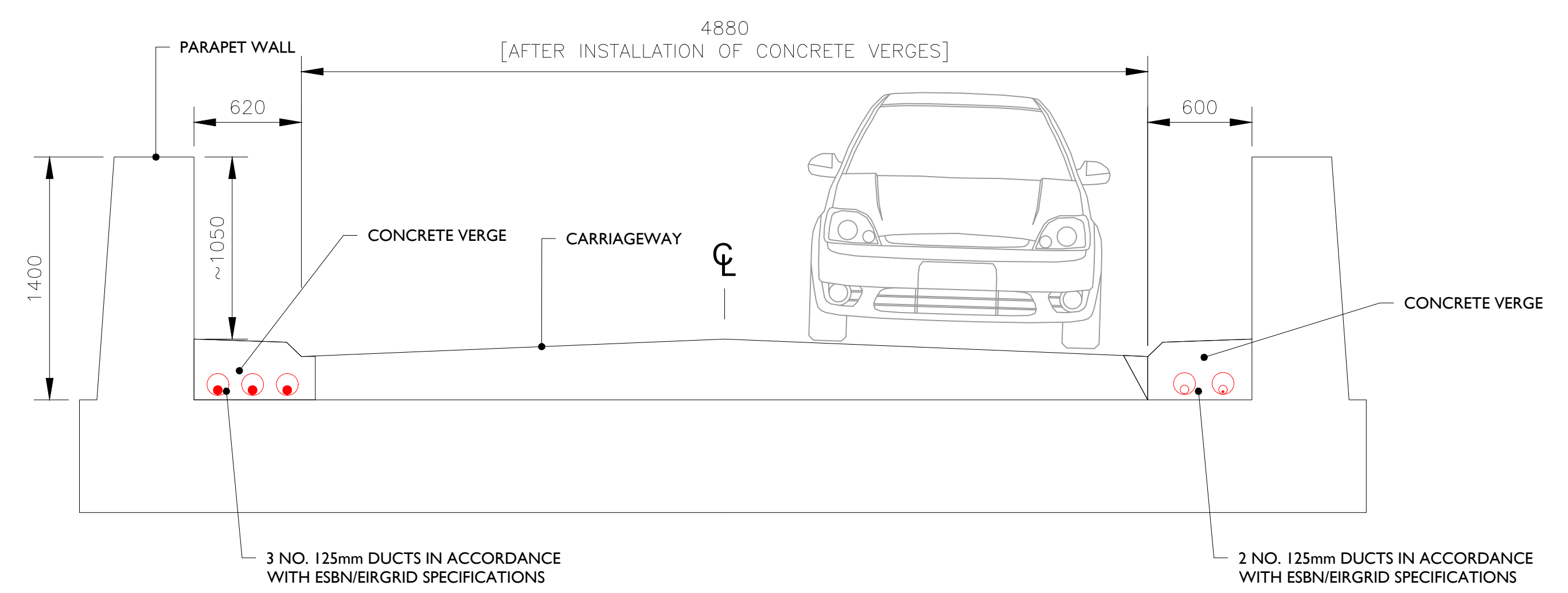

SECTION A-A - PROPOSED OPTION E DUCTS IN ROAD
SCALE 1:25



WH-1825-002.00 BRIDGE LOCATION

NOTES					 <p>The Hyde Building, The Park, Carrickmines, Dublin 18, D18VC44, Ireland E: hello@ionicconsulting.ie T: +353 (0) 1 845 5031 W: www.ionicconsulting.ie</p>		CLIENT		PROJECT		REVISION	
					ENGINEER		PAPER SIZE		TITLE		A	
					E. ANDRADE		A1		COOLE WIND FARM GRID ROUTE			
					DATE		SCALE		CLONAVA BRIDGE CROSSING			
					25/10/2022		1:25 / 1:125		WH-L1825-001.00 PROPOSED OPTION E			
					CHECKED AND APPROVED		STATUS		DRAWING NUMBER			
					J. SHANAHAN		DRAFT		COLE d005.3.7			
					DATE							
					25/10/2022							
					DRAWN BY							
					M.B.							
					J.S.							
					FIRST ISSUE							
					REV							
					DATE							
					DRAWN BY							
					CHECKED BY							
					DETAILS							

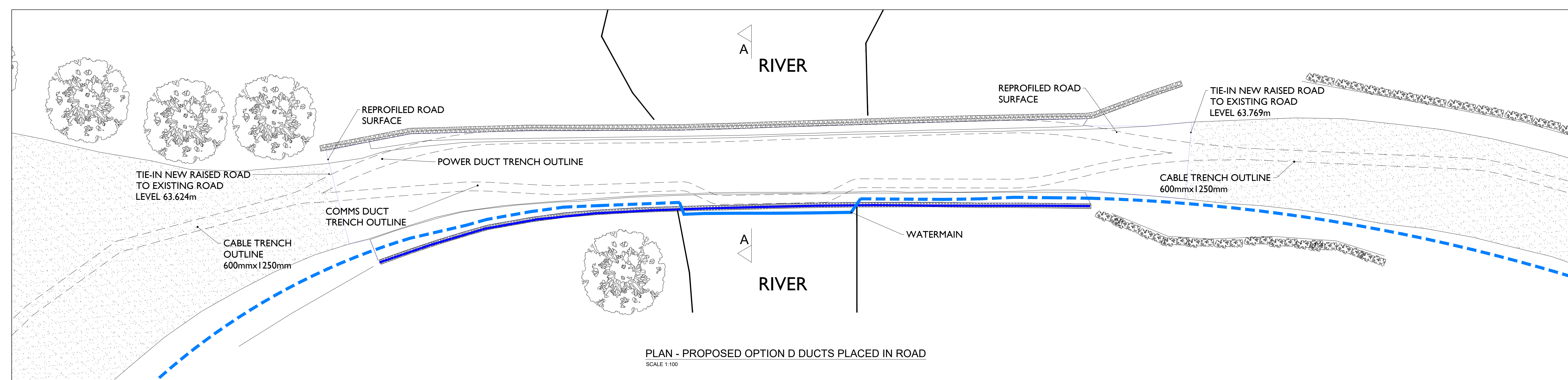

PLAN - PROPOSED OPTION D DUCTS PLACED IN ROAD

SCALE 1:100

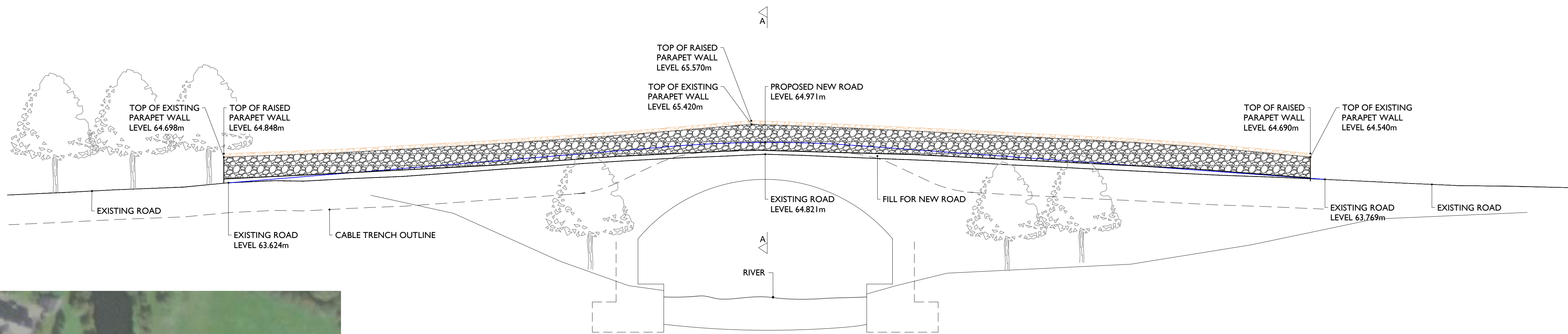

SECTIONAL ELEVATION - PROPOSED OPTION D DUCTS IN ROAD

SCALE 1:100



WH-1825-002.00 BRIDGE LOCATION

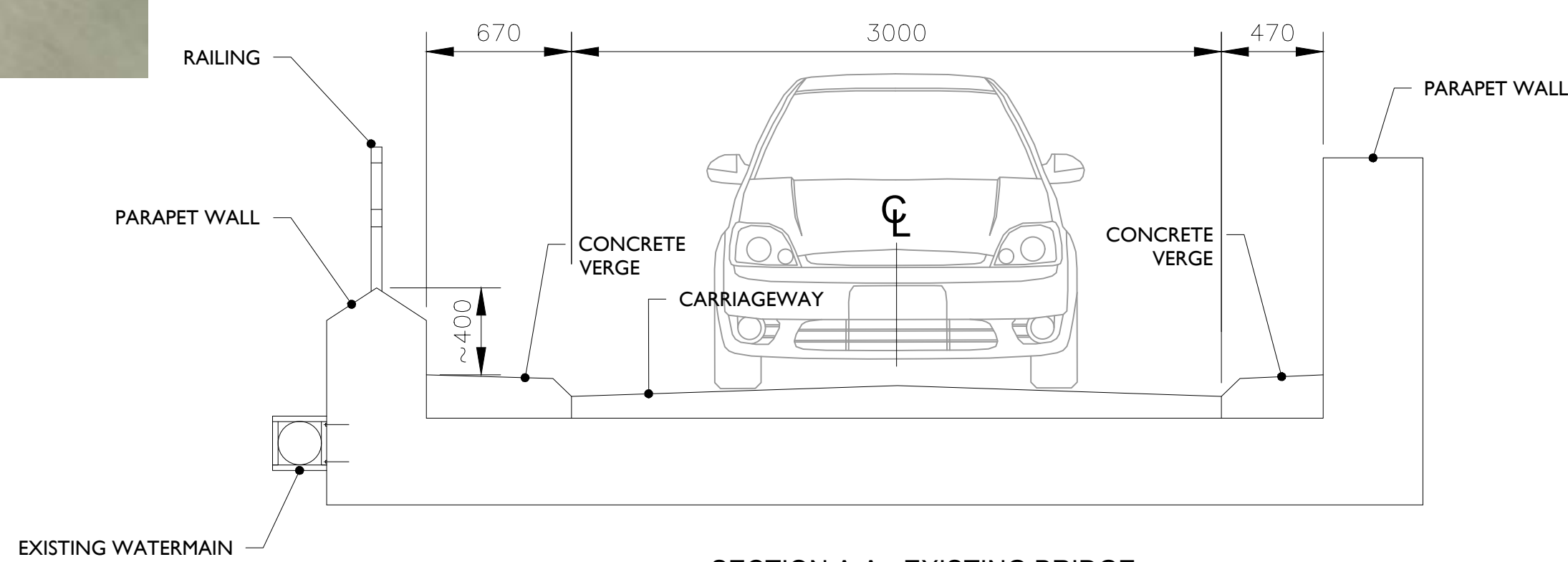

SECTION A-A - EXISTING BRIDGE

SCALE 1:25

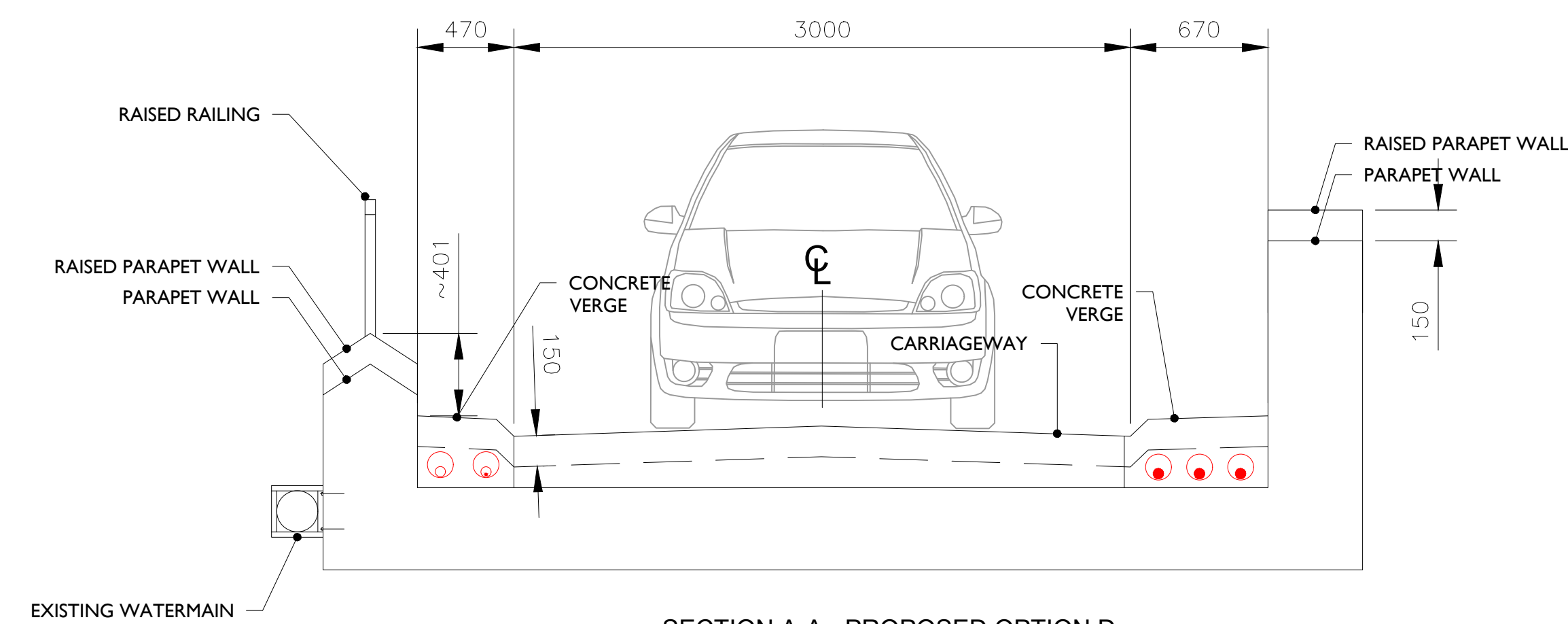

SECTION A-A - PROPOSED OPTION D

SCALE 1:25

NOTES

REV	DATE	DRAWN BY	CHECKED BY	DETAILS
B	27/10/2022	E.A.	J.S.	TRENCH OUTLINE REALIGNED
A	07/10/2022	E.A.	J.S.	FIRST ISSUE

ENGINEER	IONIC CONSULTING	The Hyde Building, The Park, Carrickmines, Dublin 18, D18VC44, Ireland E: hello@ionicconsulting.ie T: +353 (0) 1 845 5031 W: www.ionicconsulting.ie	CLIENT				
DRAWN BY	E. ANDRADE	DATE	07/10/2022	PAPER SIZE	A1	SCALE	1:100 / 1:25
CHECKED AND APPROVED	J. SHANAHAN	DATE	07/10/2022	STATUS	DRAFT		

PROJECT	COOLE WIND FARM GRID ROUTE		
TITLE	SHRUBBYWOOD BRIDGE CROSSING WH-L1825-002.00 PROPOSED OPTION D		
DRAWING NUMBER	COLE d005.3.8	REVISION	B

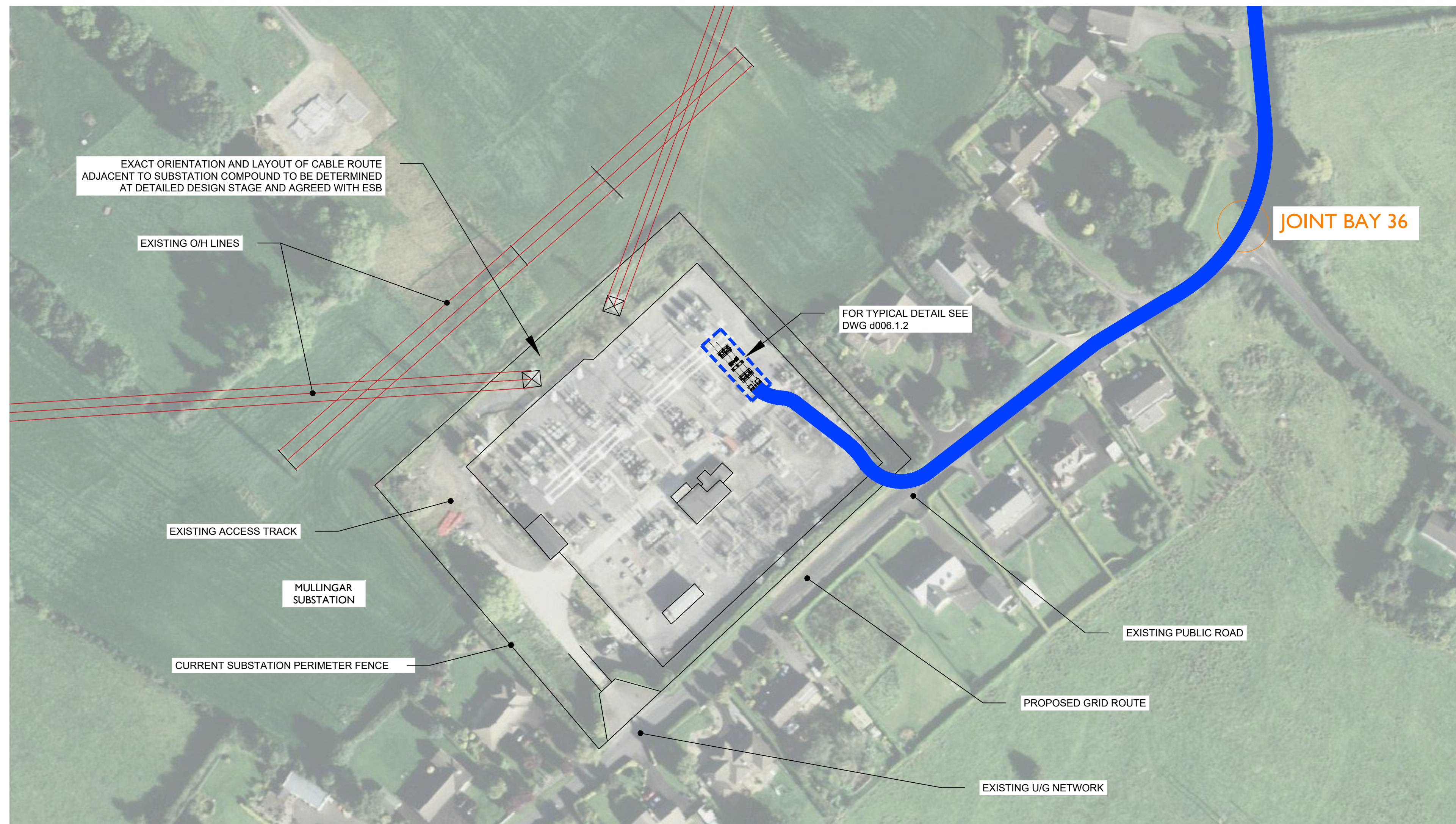
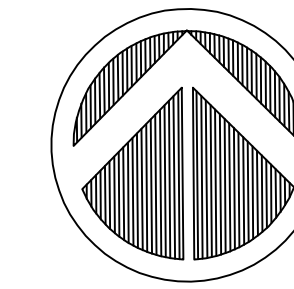

MULLINGAR SUBSTATION - ILLUSTRATIVE PLAN
Scale 1:50

Ordnance Survey Ireland License No. EN 0051322
© Ordnance Survey Ireland/Government of Ireland

NOTES

<table border="1"> <tr> <th>REV</th> <th>DATE</th> <th>DRAWN BY</th> <th>CHECKED BY</th> <th>DETAILS</th> </tr> <tr> <td>E</td> <td>13/10/2022</td> <td>E.A.</td> <td>J.S.</td> <td>ALTERNATIVE CONNECTION BAY LOCATIONS REMOVED</td> </tr> <tr> <td>D</td> <td>16/03/2022</td> <td>J.S.</td> <td>PK</td> <td>ELECTRICAL EQUIPMENT UPDATED</td> </tr> <tr> <td>C</td> <td>11/03/2022</td> <td>J.S.</td> <td>PK</td> <td>ELECTRICAL EQUIPMENT UPDATED</td> </tr> <tr> <td>B</td> <td>20/03/2020</td> <td>M.S.</td> <td>J.S.</td> <td>BAY LOCATIONS MOVED</td> </tr> <tr> <td>A</td> <td>16/01/2020</td> <td>M.B.</td> <td>J.S.</td> <td>FIRST ISSUE</td> </tr> </table>				REV	DATE	DRAWN BY	CHECKED BY	DETAILS	E	13/10/2022	E.A.	J.S.	ALTERNATIVE CONNECTION BAY LOCATIONS REMOVED	D	16/03/2022	J.S.	PK	ELECTRICAL EQUIPMENT UPDATED	C	11/03/2022	J.S.	PK	ELECTRICAL EQUIPMENT UPDATED	B	20/03/2020	M.S.	J.S.	BAY LOCATIONS MOVED	A	16/01/2020	M.B.	J.S.	FIRST ISSUE	<p>ENGINEER</p>  <p>The Hyde Building, The Park, Carrickmines, Dublin 18, D18VC44, Ireland E: hello@ionicconsulting.ie T: +353 (0) 1 845 5031 W: www.ionicconsulting.ie Formerly known as WIND PROSPECT IRELAND</p>		<p>CLIENT</p>		<p>PROJECT</p> <p>COOLE WIND FARM GRID ROUTE</p>	
REV	DATE	DRAWN BY	CHECKED BY	DETAILS																																			
E	13/10/2022	E.A.	J.S.	ALTERNATIVE CONNECTION BAY LOCATIONS REMOVED																																			
D	16/03/2022	J.S.	PK	ELECTRICAL EQUIPMENT UPDATED																																			
C	11/03/2022	J.S.	PK	ELECTRICAL EQUIPMENT UPDATED																																			
B	20/03/2020	M.S.	J.S.	BAY LOCATIONS MOVED																																			
A	16/01/2020	M.B.	J.S.	FIRST ISSUE																																			
<p>DRAWN BY</p> <p>M. BROWNE</p>				<p>DATE</p> <p>16/01/2020</p>		<p>PAPER SIZE</p> <p>A1</p>		<p>SCALE</p> <p>1:1000</p>		<p>TITLE</p> <p>MULLINGAR SUBSTATION ILLUSTRATIVE PLAN</p>		<p>REVISION</p> <p>E</p>																											
<p>CHECKED AND APPROVED</p> <p>J. SHANAHAN</p>				<p>DATE</p> <p>16/01/2020</p>		<p>STATUS</p> <p>DRAFT</p>		<p>DRAWING NUMBER</p> <p>COLE d006.1.1</p>		<p>Project: 19-02-003 (2) 01-02 E:\Projects\WindFarm\COLE\DWG\WindFarm\Substation\COLE d006.1.1.dwg 16/01/2020</p>																													

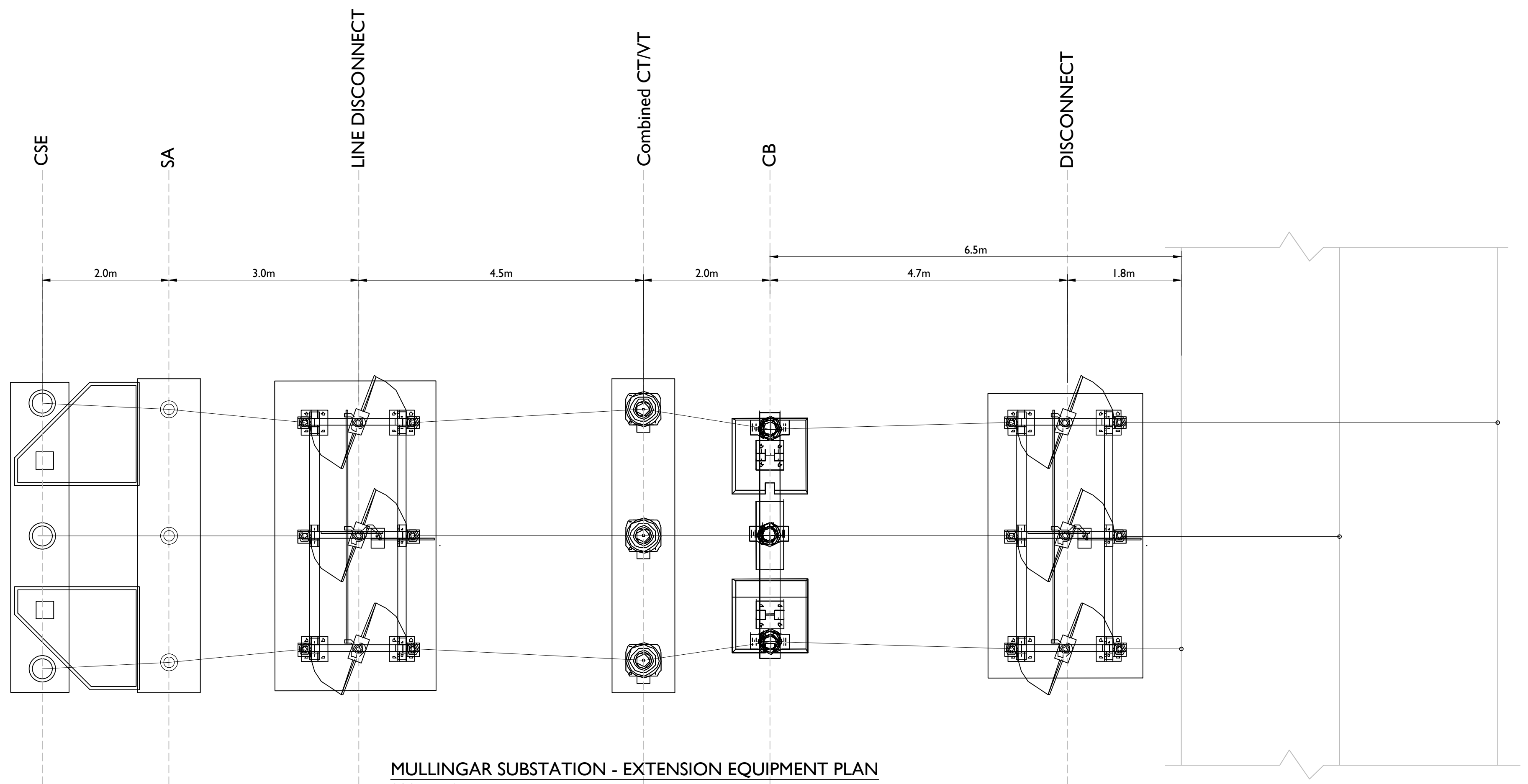

MULLINGAR SUBSTATION - EXTENSION EQUIPMENT PLAN
SCALE 1:50



MULLINGAR SUBSTATION - EXTENSION EQUIPMENT LOCATION
SCALE 1:250

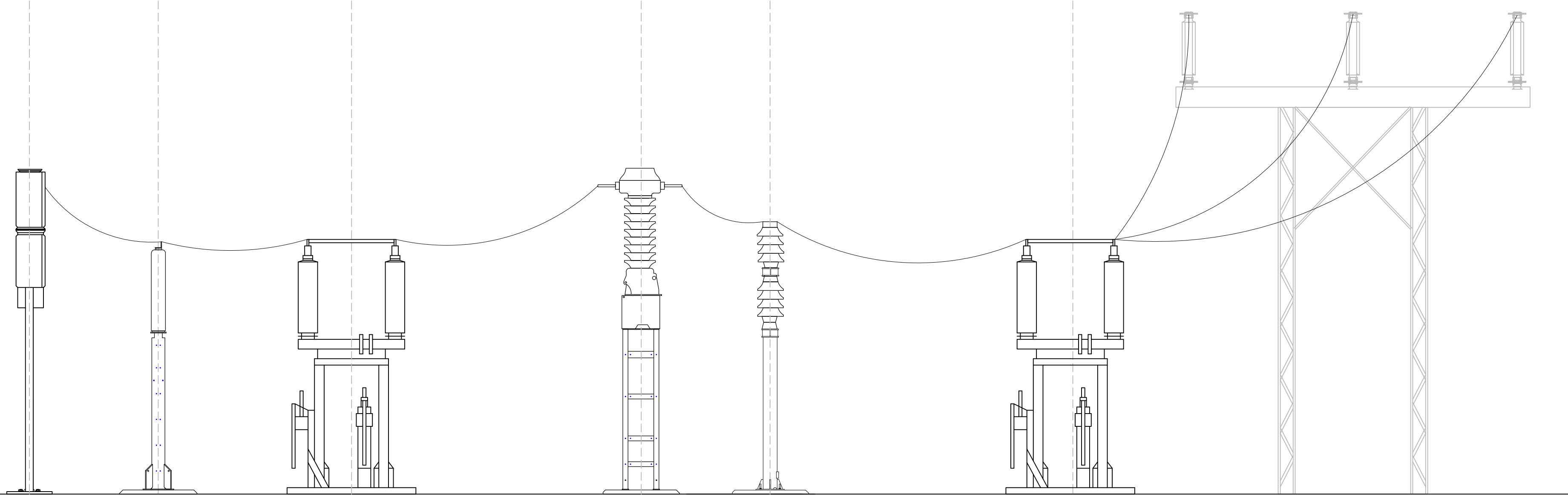

MULLINGAR SUBSTATION - EXTENSION EQUIPMENT ELEVATIONS
SCALE 1:50

Ordnance Survey Ireland License No. EN 0051322
© Ordnance Survey Ireland/Government of Ireland

NOTES
1. Confirmation of overall bay length is subject to an as-built survey within the substation area.

REV	DATE	DRAWN BY	CHECKED BY	DETAILS
E	13/10/2022	EA	J.S.	ALTERNATIVE CONNECTION BAY LOCATIONS REMOVED
D	16/03/2022	J.S.	PK	ELECTRICAL EQUIPMENT UPDATED
C	11/03/2022	J.S.	PK	ELECTRICAL EQUIPMENT UPDATED
B	20/03/2020	HS	J.S.	PLAN UPDATED
A	16/01/2020	M.B.	J.S.	FIRST ISSUE

ENGINEER  The Hyde Building, The Park, Carrickmines, Dublin 18, D18VC44, Ireland E: hello@ionicconsulting.ie T: +353 (0) 1 845 5031 W: www.ionicconsulting.ie Formerly known as WIND PROSPECT IRELAND		CLIENT 	
DRAWN BY M. BROWNE	DATE 16/01/2020	PAPER SIZE A1	SCALE As shown
CHECKED AND APPROVED J. SHANAHAN	DATE 16/01/2020	STATUS DRAFT	

PROJECT COOLE WIND FARM GRID ROUTE		REVISION
TITLE MULLINGAR SUBSTATION EXTENSION EQUIPMENT DETAILS		
DRAWING NUMBER COLE d006.1.2		